



DC INVERTER Heat Pump

Installation Manual&User Manual

(Carel controller)

Air to Water Heat

Pump

Heating+Cooling+DHW

Attention

Thank you for choosing our product, we shall be more than glad to service you. For you to better operate this product and to prevent accidents due to misoperation, please read carefully this user manual before carrying out any installation or operation, also please pay special attention to the warning, prohibition and attention instructions. We are continuously supplementing and upgrading this user manual to better service for you!

Contents

Installation Manual

| | |
|---|-----------|
| Part 1. Before use..... | 2 |
| 1. Attentions..... | 2 |
| 2. Installation..... | 4 |
| 3.R32 refrigerant introduction..... | 5 |
| 4.Heat pump installation and wiring..... | 12 |

User Manual

| | |
|--|-----------|
| Part 2.Use..... | 25 |
| ● Buttons function..... | 25 |
| ● Operating panel display..... | 26 |
| ● APP function | 37 |
| ● Parameters query and setting..... | 43 |
| Part 3.Maintenance and repairing..... | 44 |
| ● Daily maintenance..... | 44 |
| ● Error code and repairing..... | 46 |
| ● Other problem and repairing..... | 52 |
| Warranty | 54 |

Part 1. Before Use

1. Attentions



Warning



Caution



Prohibition



This appliance is not intended for use by persons, including children, with reduced physical, sensory or mental capabilities, or lack of experience and knowledge, unless they have been given supervision or instruction concerning use of the appliance by a person responsible for their safety. Children should be supervised to ensure that they do not play with the appliance.



Be sure to read this manual before use.

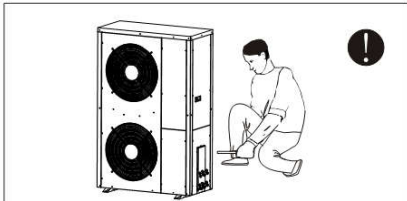

Be sure to read this manual before use. The installation, dismantling and maintenance of the unit must be performed by qualified personnel. It is forbidden to do any changes to the structure of the unit. Otherwise injury of person or unit damage might happen.

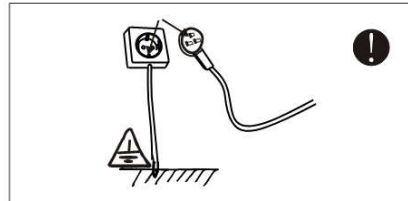

The power supply to the unit must be grounded.

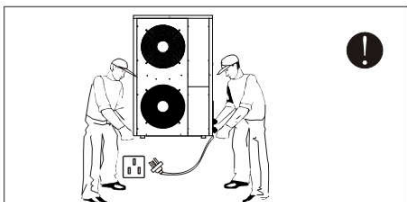

Make sure the power supply to the heat pump unit is off before any operations are done on the unit. When the power cord gets looser or is damaged, always get a qualified person to fix it.

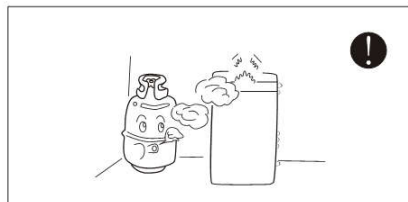

Keep the unit away from the combustible or corrosive environment.

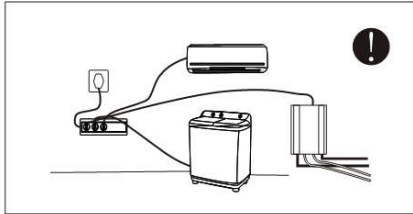

Use a dedicated socket for this unit, otherwise malfunction may occur.

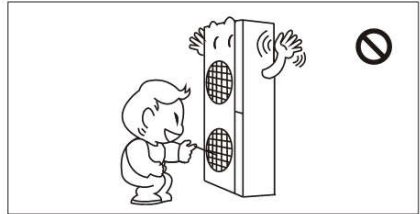

Do not touch the air outlet grill when fan motor is running.

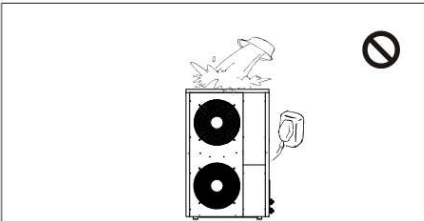

Water or any kind of liquid is strictly forbidden to be poured into the product, or may cause creepage or breakdown of the product.

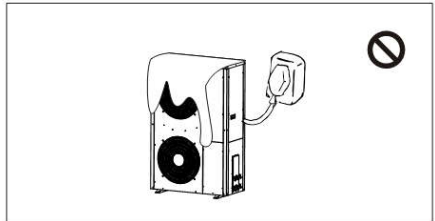

When running the unit, never cover clothes, plastic cloth or any other material that block ventilation on the product which will lead to low efficiency or even non-operation of this unit.

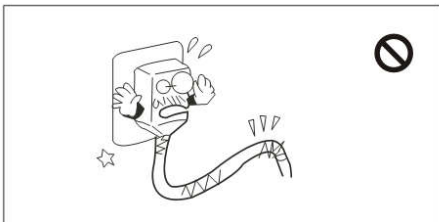

When the power cord gets loose or is damaged, always get a qualified person to fix it.

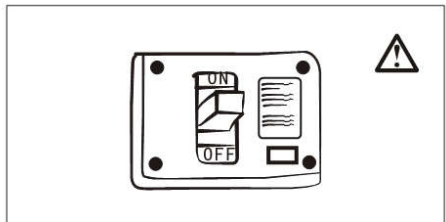

It is mandatory to use a suitable circuit breaker for the heat pump and make sure the power supply to the heater corresponds to the specifications. Otherwise the unit might be damaged.

Safety precaution

2. Installation instructions

1. Installation should comply with local regulations and requirements.
2. Choose a suitable space for use (please refer to indoor/outdoor unit location selection). The cooling capacity/heating capacity of the heat pump should be compatible with the size, height, and heat insulation effect of the room.
3. Before installation, be sure to confirm the neutral line, L, N, A phase, B phase, C phase, ground line of the user power supply and the neutral line of the heat pump, L, N, A phase, B phase, C phase, ground One correspondence.
4. This heat pump complies with the safety and operation standards issued by the country.
5. When the heat pump needs to be installed or moved. It must be operated by professional refrigeration installation and maintenance personnel. Heat pumps installed by non-professionals are prone to quality or safety problems.
6. The user should provide a power supply that satisfies the installation and use. The allowable range of voltage that can be used by this product is $\pm 10\%$ of the rated value. If this range is exceeded, it will affect the normal operation of the heat pump. If necessary, use a voltage stabilizer to avoid property damage.
7. The heat pump must have an independent circuit. The independent circuit needs to install a leakage protector and an automatic circuit breaker. Need to be purchased by the user.
8. The heat pump should be installed in accordance with the national wiring regulations.
9. The heat pump must be grounded correctly and reliably, otherwise it may cause electric shock or fire
10. Please do not turn on the power of the heat pump until the piping and wires are connected and carefully checked.

Safety precaution

3.R32 refrigerant introduction

The heat pump uses environmentally friendly R32 refrigerant. This is a slightly flammable refrigerant. Although it can burn and explode under certain conditions, as long as it is installed in a room of the correct area and used correctly, there will be no danger of combustion and explosion. Compared with ordinary refrigerants, R32 is an environmentally friendly refrigerant that does not destroy the ozone layer, and its greenhouse effect value is also very low.

R32 heat pump room area requirements

The area of the heat pump installation, operation and storage room should be larger than 4 square meters.



Warning

1. Please read this manual before installation, operate and maintenance.
2. Except as specifically recommended by the manufacturer, pls do not use any method to speed up the defrosting process or clean the frosted part.
3. Pls do not puncture or ignite the heat pump.
4. The heat pump should be stored in a room without a continuous fire source (such as gas appliances ignited by an open flame, electric heaters, etc.).
5. When repairs are required, please contact the nearest after-sales service center. When repairing, you must strictly abide by the operation manual provided by the manufacturer, and it is forbidden to repair by non-professionals.
6. Pls comply with the relevant national gas laws and regulations.
7. The refrigerant in the system needs to be recovered and removed during maintenance or disposal.



Safety precaution

Repair of sealing elements

1. When repairing closed components, disconnect the power supply to the equipment before opening the sealed cover. If power supply is necessary during the maintenance process, continuous leak detection should be performed on the most dangerous parts to prevent potentially dangerous situations from happening.

2. In the following maintenance of electrical components, special care should be taken not to affect the protection level of the enclosure. Improper maintenance methods may cause: damage to cables, excessive connections, terminals not installed according to the original regulations, damage to the seal, incorrect installation of the sealing cover and other dangers. Ensure that the installation of the equipment is safe and reliable. Ensure that the sealing or sealing material will not lose its function of preventing the entry of flammable gas due to aging. Replacement parts should meet the manufacturer's specifications.

Note: The use of silicon-containing sealants may reduce the detection capabilities of leak detection equipment. Intrinsically safe components do not need to be isolated before operation.

Maintenance of intrinsically safe components

If it is not possible to ensure that the heat pump does not exceed the allowable voltage and current limits during use, do not use any permanent inductive or capacitive load in the circuit.

Intrinsically safe components are the only components that can continue to work in flammable gases. The test instrument should be set in the correct gear.

The replacement components can be only used the parts specified by the manufacturer, other parts may cause the refrigerant leaking in the air to catch fire.

Cable

Check whether the cable will be affected by wear, corrosion, overpressure, vibration, sharp edges or other adverse environments. The inspection should also consider the influence of aging or continuous vibration of the compressor and fan on the cable.

Leak inspection of R32 refrigerant

Check for refrigerant leakage should be done in an environment where there is no potential ignition source. Halogen probes (or any other detectors that use open flames) should not be used for detection

Safety precaution

Leak detection method

For systems containing R32 refrigerant, an electronic leak detector can be used for testing. The test should be calibrated in a refrigerant-free environment to ensure that the leak detector does not become a potential source of ignition and is suitable for the refrigerant being tested. The leak detector should be set to the lowest flammable concentration of the refrigerant (expressed as a percentage), calibrated with the refrigerant used and adjusted to the appropriate gas concentration test range (up to 25%).

The fluid used to detect leaks is suitable for most refrigerants, but do not use chlorine-containing solvents to prevent chlorine and refrigerants from reacting and corroding copper pipes.

If a leak is suspected, all open flames should be removed from the scene or the fire should be extinguished.

If welding is required at the location where the leakage occurs, all refrigerants should be recovered, or all refrigerants should be isolated away from the leakage point (use shut-off valves). Oxygen-free nitrogen (OFN) is used to purify the entire system before and during welding.

Remove and vacuum

Maintenance or other operations on the refrigeration circuit should be performed in accordance with normal procedures. However, the safety should also be considered, and the following procedures should be followed:

1. Remove refrigerant;
2. Purify the pipeline with inert gas;
3. Vacuum;
4. Purify the pipeline with inert gas again;
5. Cut the pipe or weld it.

The refrigerant should be recycled into a suitable storage tank. The system should be purged with oxygen-free nitrogen. This process may need to be repeated several times. Do not use compressed air or oxygen for this operation.

In the purging process, the system is filled with oxygen-free nitrogen to reach the working pressure under the vacuum state of the system, and then the oxygen-free nitrogen is discharged into the atmosphere, and finally the system is evacuated. Repeat this process until all refrigerant in the system is removed. After filling the oxygen-free nitrogen for the last time, exhaust the gas to atmospheric pressure, and then the system can be welded. The above operations are necessary for pipeline welding operations.

Ensure that there is no ignition source near the outlet of the vacuum pump and good ventilation.

Safety precaution

Procedure of refrigerant filling

As a supplement for the conventional procedures, the following requirements have been added:

1. Ensure that when using equipment of refrigerant filling, there will not be the mutual contamination between different refrigerants. The pipeline of refrigerant filling should be as short as possible to reduce the residual amount of refrigerant;
2. When filling refrigerant, there should be without the fire source near the unit;
3. Make sure that the refrigerant system has taken grounding measures before charging the refrigerant;
4. After filling refrigerant (or not finished), stick the label on the system;
5. Must be careful not excessive filling;

Perform a pressure test with oxygen-free nitrogen before refilling refrigerant into the system. After filling, a leak test must be carried out before the trial operation. The leak test must be carried out again when leaving the area.

Scrapping

Before proceeding with this procedure, the technician should be fully familiar with the equipment and all of its characteristics. It is recommended to recover safe refrigerant. If it is necessary to re-use the recovered refrigerant, samples of refrigerant and oil should be analyzed before operation. Before testing, please ensure that you have got the required power source.

Being familiar with the equipment and its operation;

2. Disconnecting the power supply;
3. Before proceeding with this procedure making sure that:

If necessary, the equipment of mechanical operation should be convenient to operate the refrigerant storage tank;

All personal protective equipment are effective and can be used correctly;

The entire recycling process should be carried out under the guidance of qualified persons; Recycling equipment and refrigerant storage tanks should meet the corresponding standards.

Maintenance safety matters

Warning

1. For repairs or scrapping, please contact the nearest or authorized service center.
2. Repairs performed by unqualified personnel may be dangerous.
3. When charging the heat pump with R32 refrigerant and maintaining it, please strictly observe the manufacturer's requirements. This chapter mainly focuses on the special maintenance requirements of R32 refrigeration appliances. Please refer to the after-sales service manual for

Safety precaution

detailed maintenance operations.

Qualification requirements for maintenance personnel

1. All operating personnel or refrigeration circuit maintenance personnel should obtain a valid certificate issued by an industry-recognized evaluation agency to determine that they have the qualifications for safe handling of refrigerants as required by the industry-recognized evaluation specifications.
2. The maintenance and repair of the equipment can only be carried out in accordance with the method recommended by the equipment manufacturer. If other professionals are required to assist in maintaining and repairing the equipment, it should be carried out under the supervision of personnel qualified to use flammable refrigerants.

Site inspection

Before repairing heat pumps using R32 refrigerant, safety inspections must be carried out to ensure that the risk of fire is minimized. When servicing the refrigeration system, the following precautions should be observed before handling the system.

Operational procedure

Operations should be carried out under a controlled procedure to ensure that the risk from combustible gases or vapors is minimal during operations.

General operating area

All maintenance people and other people in the operation area should be aware of the character of the operation being performed. Avoid working in confined Spaces. Work areas should be properly isolated to ensure safe working conditions within the work area by controlling combustible materials.

Check whether the refrigerant is present

Refrigerant monitors are necessary to be used in the area before and during operations to ensure that technicians are aware of the presence of potentially combustible gases. Ensure that the leak detection equipment used is suitable for R32 refrigerants, such as sparkless, fully sealed, or intrinsically safe.

Placement of fire extinguishers

The applicable fire extinguisher should be located close to the cooling system or related components during hot working operations. The refrigerant injection area should be equipped with dry powder or carbon dioxide fire extinguisher.

No fire

Any fire sources should not be used when performing work related to exposed pipes that hold or have held R32 refrigerant which may cause a fire or explosion hazard. All sources of fire,

Safety precaution

including smoking, should be kept away from the area of installation, repair, removal and disposal of combustible refrigerants that may release into the surrounding environment. Before starting operations, check the environment around the equipment to ensure that there is no danger of flammability or fire. There should be a "no smoking" sign.

Ventilated area

Ensure that the work area is open or fully ventilated before opening the system or performing thermal processing operations. Keep ventilation during operation. Ventilation will safely dilute the leaked refrigerant and quickly discharge it into the atmosphere.

Inspection of refrigeration equipment

If the electrical components are replaced, these electrical components should be installed in accordance with the purpose of use and correct operation regulations. At all times, you should follow the manufacturer's maintenance and repair guidelines. If you have any questions, please consult the manufacturer's technical department. For installations using R32 refrigerant heat pumps, the following inspection items apply:

1. The filling amount should be determined according to the marked amount on the heat pump's rating plate.
2. The ventilation equipment should operate normally, and the vents should be unobstructed.
3. If an indirect refrigeration cycle is used, please check whether there is refrigerant in the secondary circuit.
4. The logo or marking on the heat pump should be clearly visible, and the ambiguous signs and symbols should be corrected;
5. Refrigeration piping or electrical components should not be installed in an environment that contains components that may be corrosive to contact the refrigerant, unless the electrical components themselves are made of anti-corrosion materials or take appropriate anti-corrosion measures.



- a. To avoid electrical shock, make sure to disconnect power supply 1 minute or more before operating the electrical part. Even after 1 minute, always measure the voltage at the terminals of main circuit capacitors or electrical parts and, before touching, make sure that those voltages are lower than the safety voltage.
- b. Power supply wire line size must be selected according to this manual. And must be grounded.
- c. Don't put in hands or stick to air outlet grill when fan motor are working.

Safety precaution

- d. Don't use wet hand touch wire lines, and don't pull any wire lines of the unit.
- e. Water or any other kind liquid is forbidden to poured into the unit.
- f. Select correct air breaker and leakage protection switch.
- g. Don't touch the fin of source side heat exchanger, it may hurt your finger.
- h. If any wire line is loose or damaged, suggest let qualified person to fix i

Important parts in heat pump

4.Heat pump installation and wiring

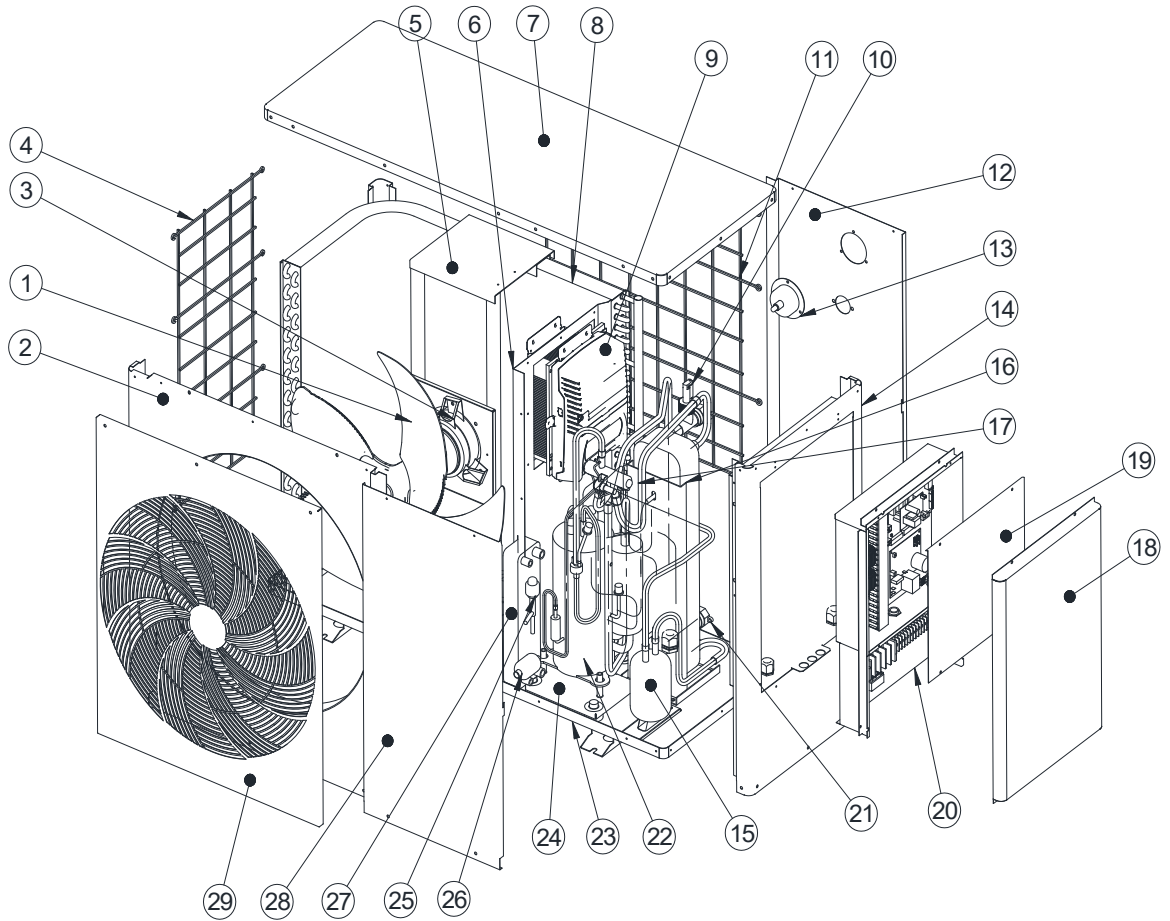

CGK030V3L、CGK-030V3L

| No. | Component | No. | Component |
|-----|---------------------|-----|--------------------------------------|
| 1 | Wind leafd | 16 | Plate heat exchanger (condenser) |
| 2 | Air outlet plate | 17 | Four way valve |
| 3 | Fan motor | 18 | Electric box cover plate |
| 4 | Side wire mesh | 19 | Cover plate of internal electric box |
| 5 | Fan support | 20 | Electric control panel |
| 6 | Middle diaphragm | 21 | Inlet and outlet pipe connection |
| 7 | Cover | 22 | Compressor |
| 8 | Evaporator | 23 | Chassis |
| 9 | Frequency converter | 24 | Damping plate |
| 10 | Water flow switch | 25 | Electronic expansion valve |
| 11 | Rear wire mesh | 26 | Copper filter |
| 12 | Rear service panel | 27 | Plate heat exchanger (economizer) |
| 13 | Pressure gauge | 28 | Front service panel |
| 14 | Right side panel | 29 | Air outlet network |
| 15 | Reservoir | | |

Important parts in heat pump

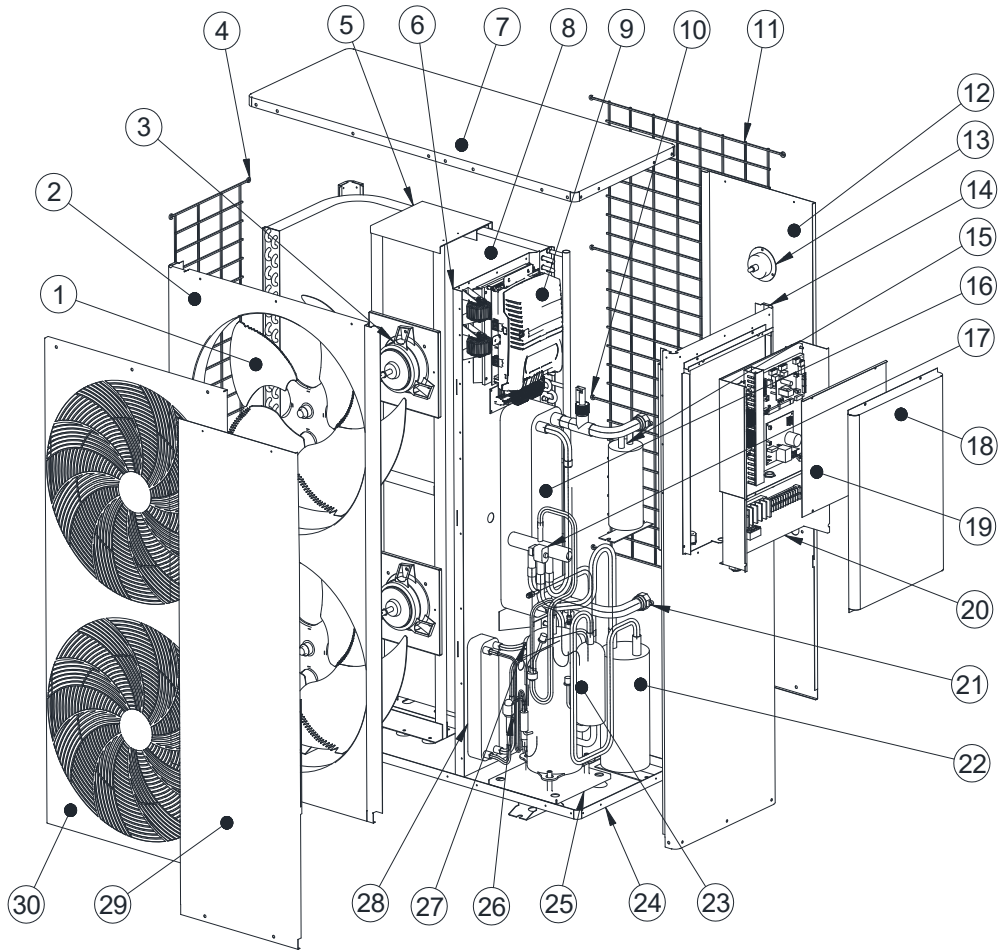

CGK050V3L、CGK-050V3L、CGK060V3L、CGK060V3L

| No. | Component | No. | Component |
|-----|---------------------|-----|--------------------------------------|
| 1 | Wind leafd | 16 | Plate heat exchanger (condenser) |
| 2 | Air outlet plate | 17 | Four way valve |
| 3 | Fan motor | 18 | Electric box cover plate |
| 4 | Side wire mesh | 19 | Cover plate of internal electric box |
| 5 | Fan support | 20 | Electric control panel |
| 6 | Middle diaphragm | 21 | Inlet and outlet pipe connection |
| 7 | Cover | 22 | separator |
| 8 | Evaporator | 23 | Compressor |
| 9 | Frequency converter | 24 | Chassis |
| 10 | Water flow switch | 25 | Damping plate |
| 11 | Rear wire mesh | 26 | Electronic expansion valve |
| 12 | Rear service panel | 27 | Copper filter |
| 13 | Pressure gauge | 28 | Plate heat exchanger (economizer) |
| 14 | Right side panel | 29 | Front service panel |
| 15 | Reservoir | 30 | Air outlet network |

Heat pump size

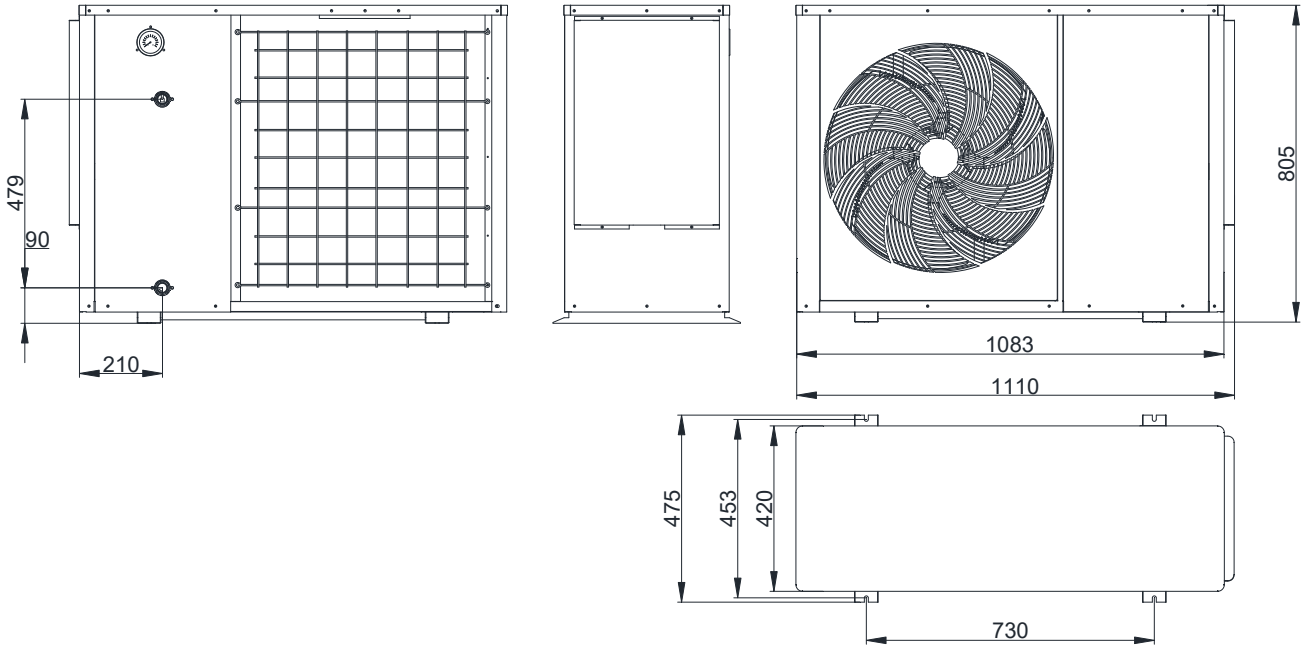

GK030V3L、CGK-030V3L

Heat pump size

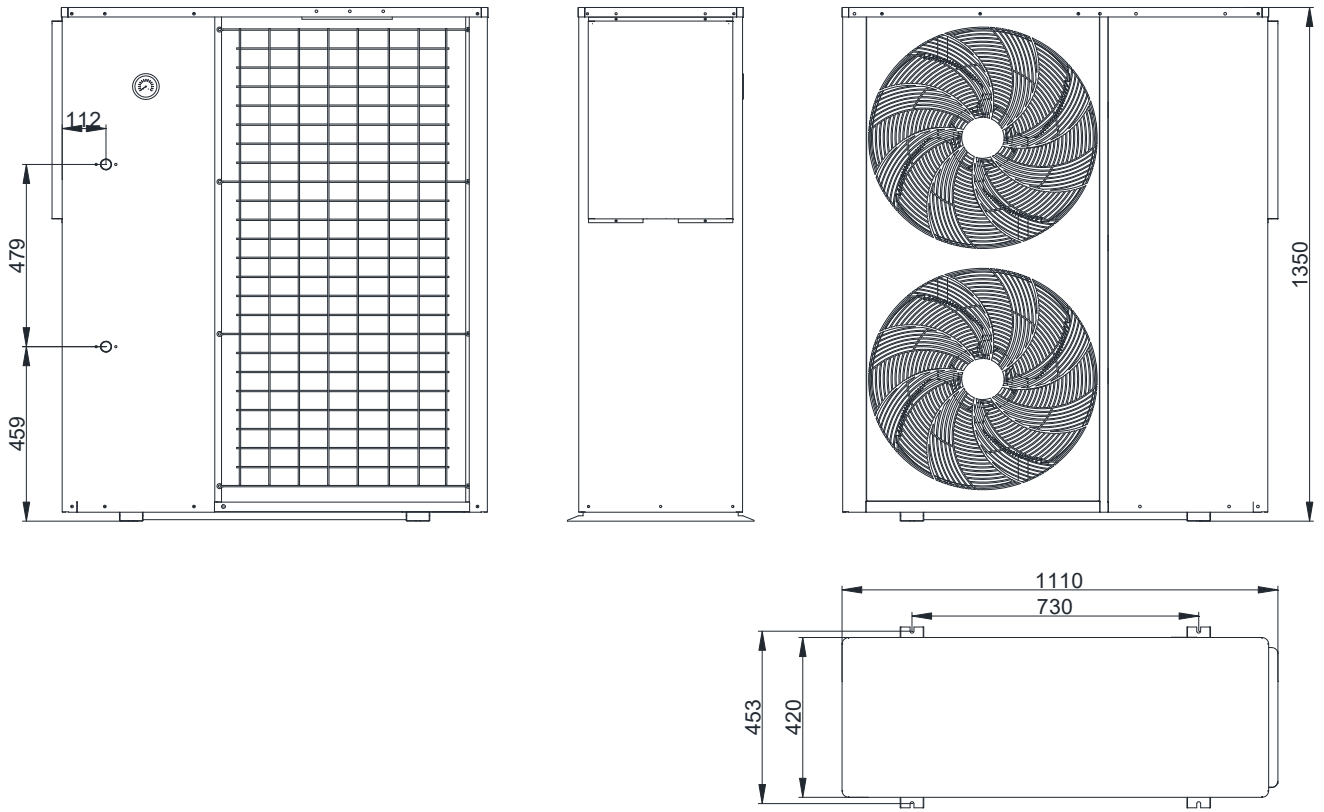

CGK050V3L、CGK-050V3L、CGK060V3L、CGK-060V3L

Installation diagram

Primary circulation system

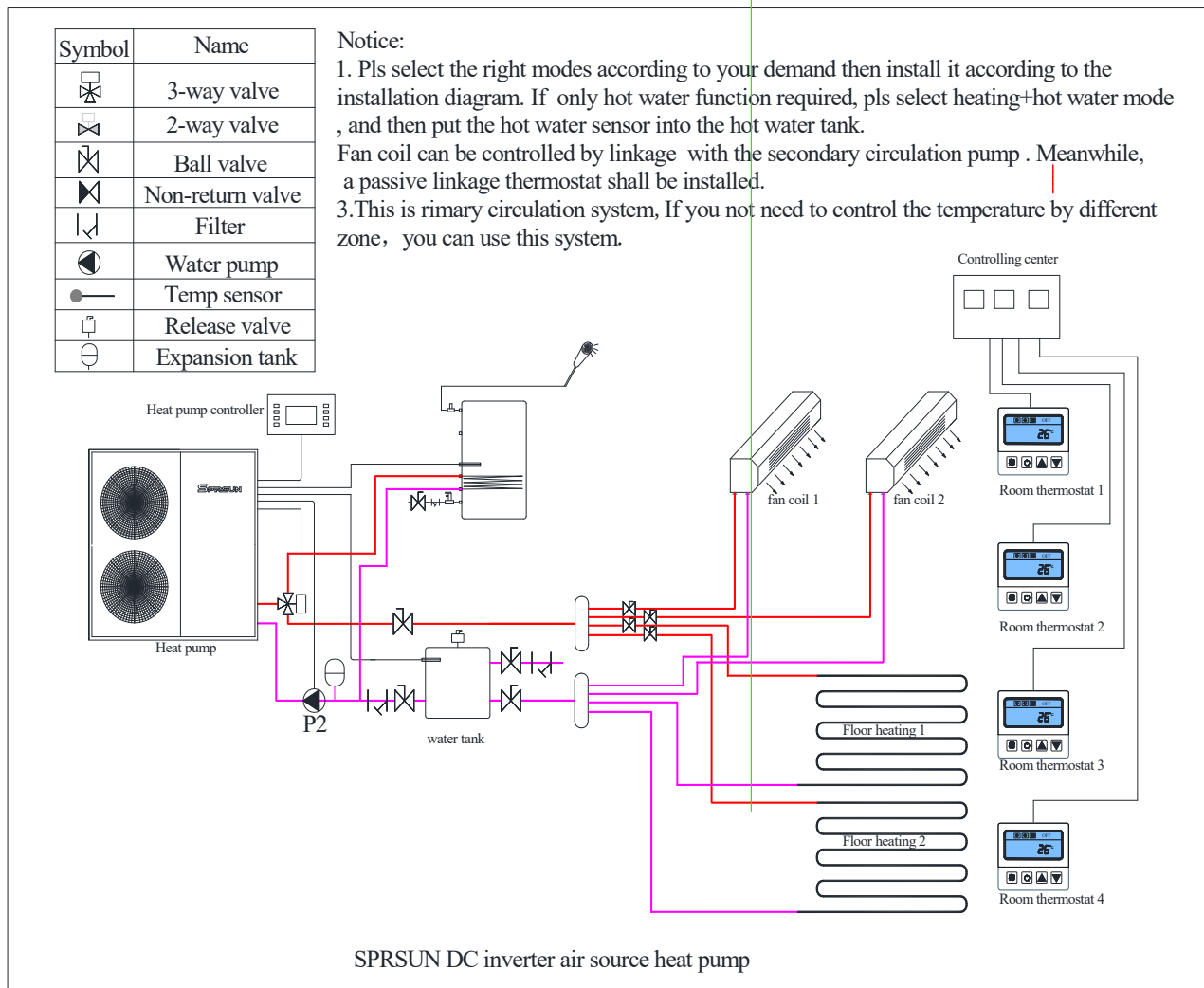

Installation diagram

Secondary circulation system

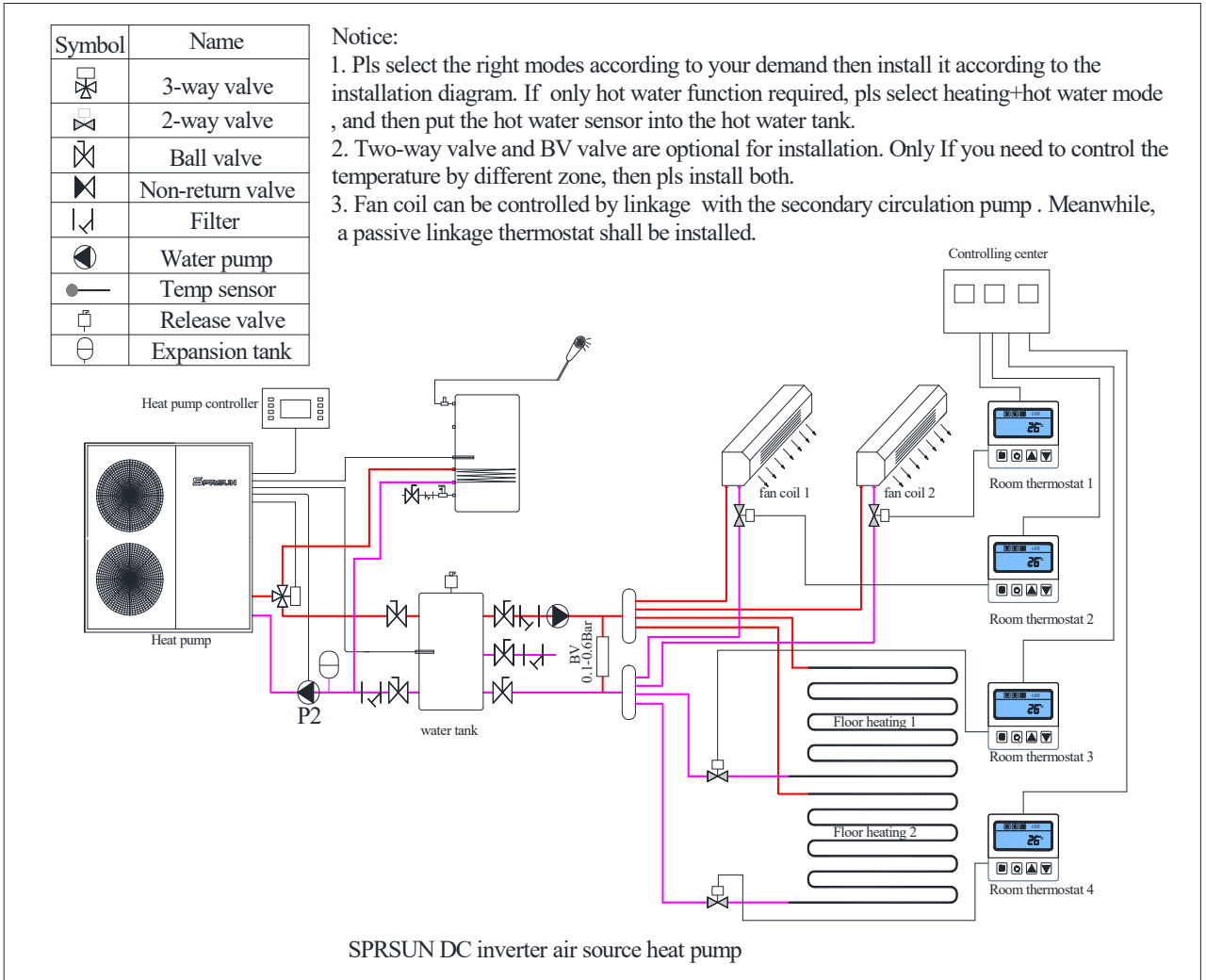

Heat pump installation notes

- 1) The heat pump must be installed in open space. Normally is installed on the roof of house.
- 2) The unit should be placed in dry and well-ventilated environment. If the environment is humid, electronic components may get corroded or short circuit.
- 3) Heat pump mustn't be installed in the environment where corrosive, volatile, or flammable liquid or gas exists.
- 4) Because of the noise is a little loud, please don't install the heat pump near bedroom or living room or meeting room.
- 5) The bottom of the heat pump should be at least 200mm higher than ground, because rain water, snow may enter inside if the installation is on ground. Heat pump can be installed on concrete basic or steel support.
- 6) Please install a shed for the heat pump, otherwise, rain water can reduce the lifetime of the shell, and snow may cover the air outlet.
- 7) Water drainage ditch should be set around the heat pump, when heat pump is working, there is condensing water flow down, or when defrosting, there are plenty of water flow down too.
- 8) Heat pump should far away from kitchen exhaust, because the finned tube is not easy to clean if there is oil on it.

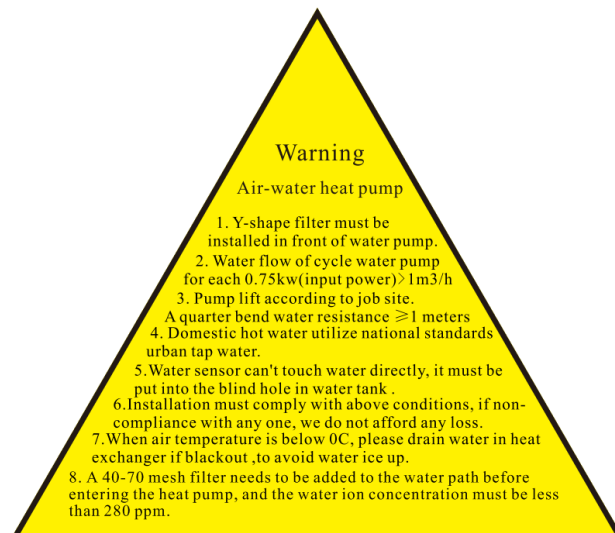

Distances to barrier and ground

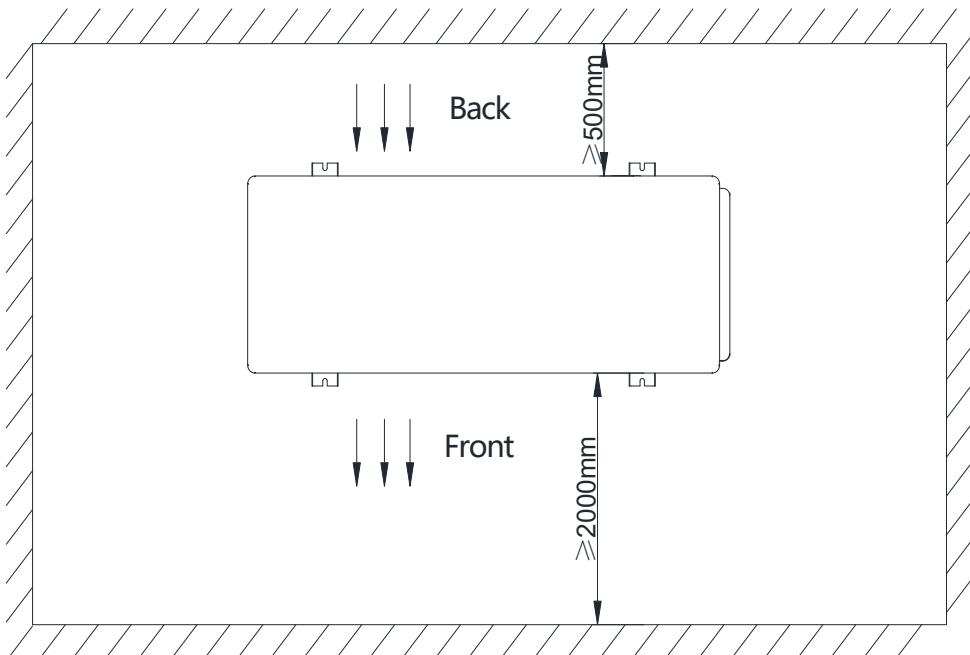
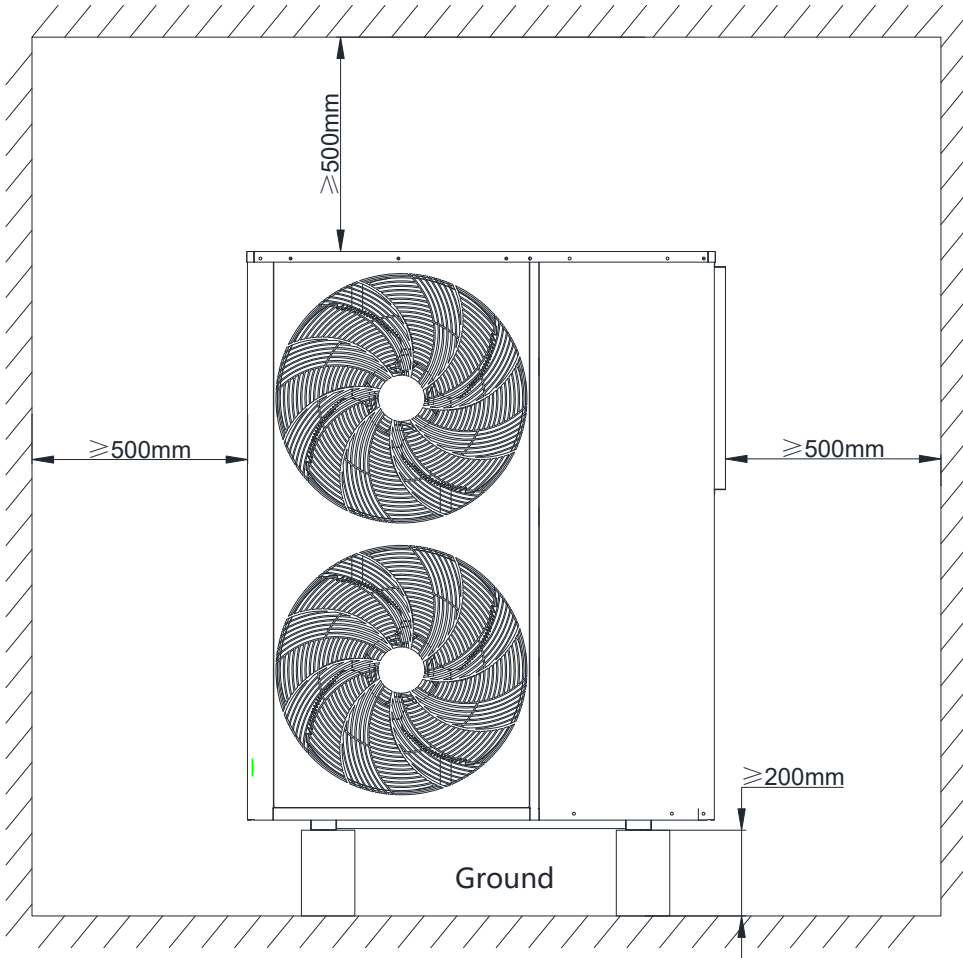

Basic of installation

- 1) Heat pump must be installed on flat concrete blocks or a raised concrete platform, or steel bracket.
- 2) Between heat pump and basic or bracket, at least 4 pcs anti-shock pads should be placed



Concrete basic

Anti-shock pad



Steel bracket



Expansion bolt

- 3) Before make basic or bracket, please check heat pump dimension
- 4) Before fix heat pump on basic, please confirm heat pump direction according to project design.
- 5) Normally use expansion bolt to fix heat pump on concrete basic.
- 6) Make sure circulating water pipe must be \geq DN25 (or PPR32), and pipes must be insulated.
- 7) When install water temp sensor on pipe or in water tank, make sure temp sensor will not touch water directly, best through a sensor tube. Like below picture.

Wiring diagram

220V

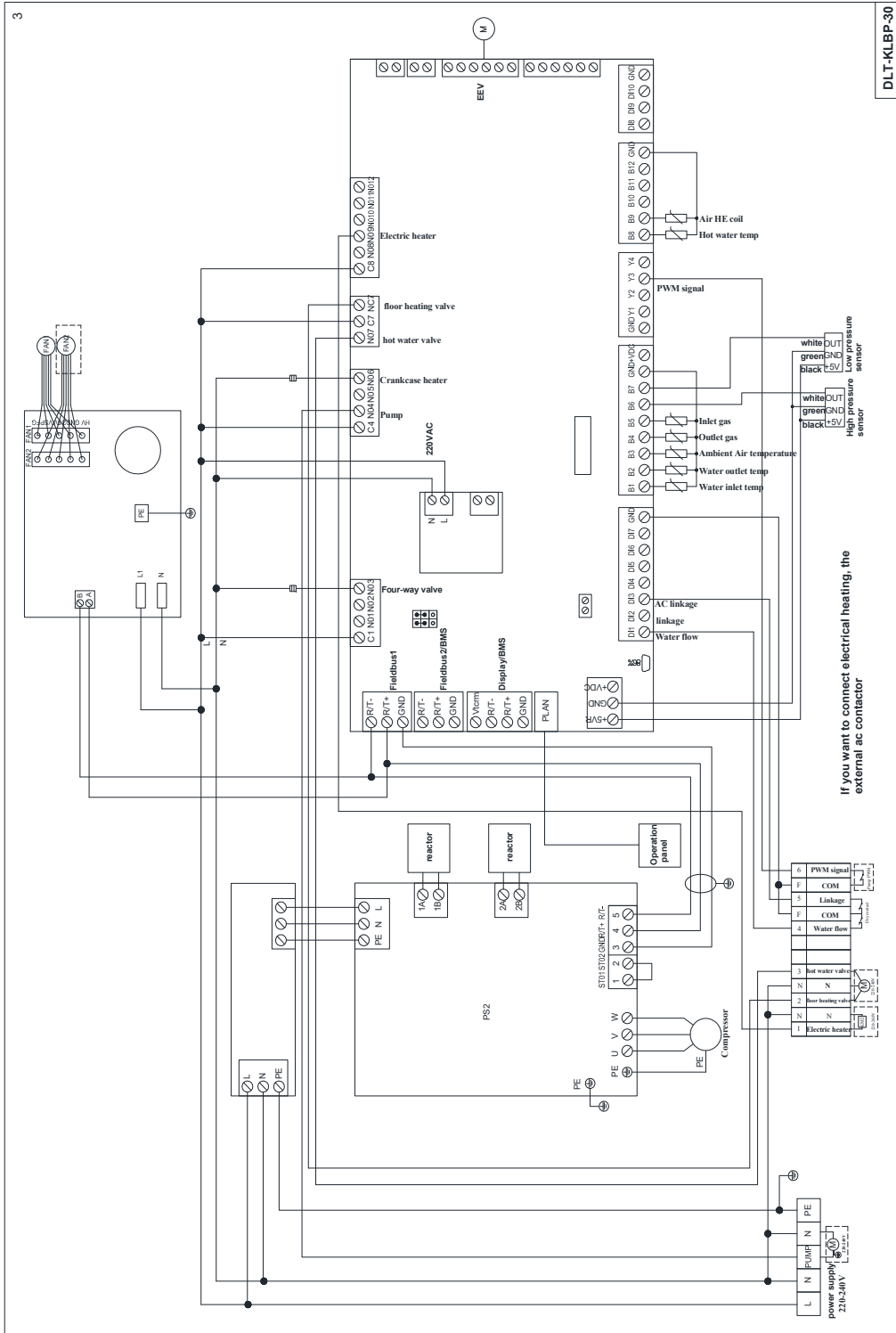

Voltage: 220V ~ 240V/50Hz or 60 Hz/1Ph

Wiring diagram

380V

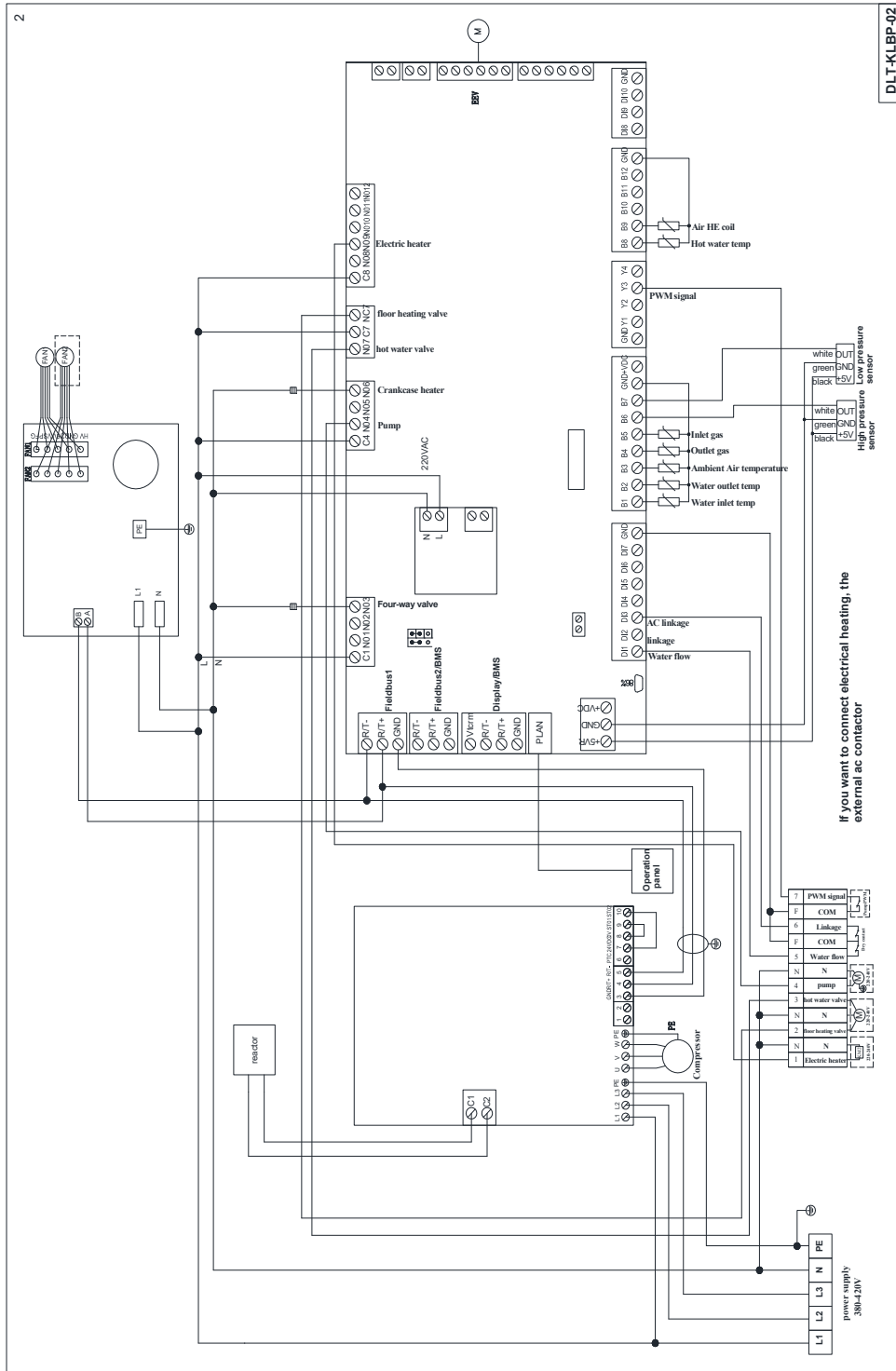

Voltage: 380V ~ 420V/50Hz or 60 Hz/3Ph

Terminals

220V

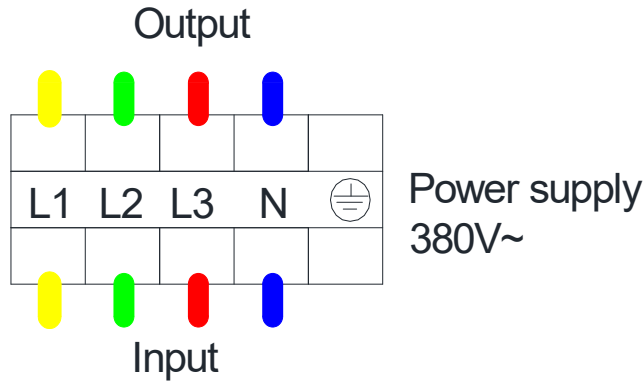

| Model | Line(mm ²) | Max. Current(A) |
|-----------|------------------------|-----------------|
| CGK-030V2 | 2.5 | 8.25 |
| CGK-050V2 | 4 | 12.86 |
| CGK-060V2 | 4 | 14.48 |

| L1 | L2 | L3 | N | PE |
|----|----|----|---|----|
|----|----|----|---|----|

Power supply
380-420V

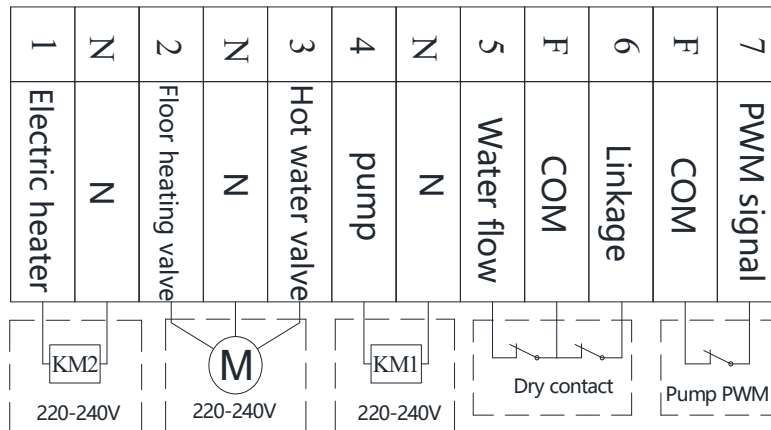

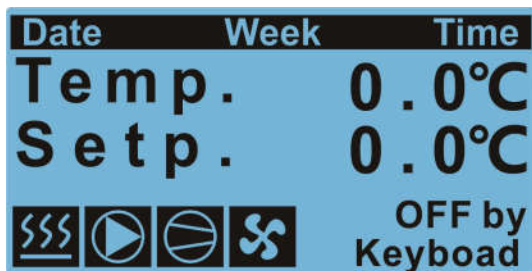

Part 2. Use

Main interface



The icon:

1, Heating mode 

2, Pump 

3, Compressor 

4, Fan 

5, Defrost 

6, Cooling mode 

7, Alarm 

8, Exit 



9, Menu & Confirm 

10, Select  

11. Factory parameters







1. Turn on/off

Press  to access menu, press \uparrow / \downarrow button to select Unit On/Off, then press

 to confirm. Press \uparrow / \downarrow Button to turn on/off, and press  to confirm:



2. Mode switching (Heating, Cooling, Hot water, Hot water+cooling, Hot water+heat)

Press  to access menu, press   button to select User Mask, then press  to confirm. Press   Button to switch mode, and press  to confirm, Egc. Mode switching&Temperature setting.

Attention: Only switch mode when the unit is turn off

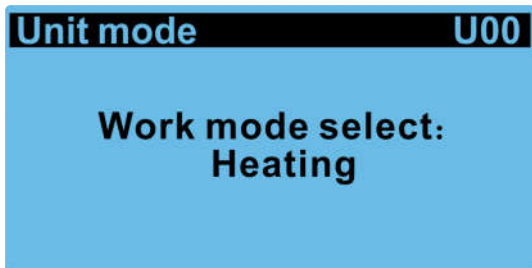

The setting temperature interface is as follows:

Heating setp: heating setting temperature

Cooling setp: cooling setting temperature

Hotwater setp: hot water setting temperature

| Setpoint | U01 |
|-----------------|--------|
| Heating setp.: | 45.0°C |
| Cooling setp.: | 12.0°C |
| Hotwater setp.: | 50.0°C |

Set Temp.diff and Stop temp. diff. of hot water

Temp.diff: The difference between the unit restart temperature and the set temperature after standby.

Stop temp.diff: The difference between the unit's shutdown temperature and the set temperature after reaching the setting temperature.

| Setpoint | U02 |
|-------------------|-------|
| Hot water setp. | |
| Temp. diff.: | 5.0°C |
| Stop temp. diff.: | 0.0°C |

Set Temp.diff and Stop temp. diff. of heating and cooling

Temp.diff: The difference between the unit restart temperature and the set temperature after standby.

Stop temp.diff: The difference between the unit's shutdown temperature and the set temperature after reaching the setting temperature.

| Setpoint | U03 |
|--------------------|-------|
| Cool and heat mode | |
| Temp. diff.: | 5.0°C |
| Stop temp. diff.: | 2.0°C |

Set PID

Kp: The larger the value, the faster the heat pump adjustment speed (not

recommended to adjust this parameter).

Integral and Differential: (not recommended to adjust this parameter).

| Setpoint | U04 |
|-----------------------|--------------|
| PID management | |
| Kp: | 5.0°C |
| Integral: | 200s |
| Differential: | 0s |

Pump work:

Normal - the water pump is always on during standby; Interval, the water pump is on every 3 minutes during standby;

Demand - the water pump stops during standby.

Pump auto:

ENABLE - the water pump is automatically turned on according to the temperature difference adjustment;

DISABLE - the water pump is automatically turned off according to the temperature difference adjustment.

| Pump control | U05 |
|---------------------|-----------------|
| Pump work: | Interval |
| Pump auto: | ENABLE |

Fan mode:

Ecomode - economic mode, the heat pump can automatically output capacity

as required according to the ambient temperature;

Nigt - night mode, the heat pump has low output capacity from 8 pm to 8 am, and high output at other times; Daytime, day mode, the compressor outputs according to the maximum capacity; Pressure, test mode, the heat pump outputs according to the test capacity.

Enable heater:

ALL-both floor heating and hot water mode enable electric heating; This mode electric heater must be installed on the main pipe.

Heating-only start electric heating in heating mode; This mode electric heater must be installed in the expansion water tank.

Hot water-only enable electric heating in hot water mode; This mode electric heater must be installed in the hot water tank.

Disable - disable electric heating.

Enable chassis/crank:

Enable - enable chassis electric heating/crankshaft electric heating;

Disable - disable chassis electric heating/crankshaft electric heating.

| User configure | | U06 |
|------------------------------|--|---------|
| Fan mode: | | Daytime |
| Enable heater: | | ALL |
| Enable chassis/crank heater: | | Enable |

Heater control:

Comp.delay: The delay time to start the electric heating after the compressor starts, the default is 50 minutes.

Ext.temp.setp: The maximum allowable ambient temperature for starting electric heating, the default is -15 degrees.

| | |
|-------------------------|----------------|
| Heater control | U07 |
| Comp.delay: | 50min |
| Ext.temp. step.: | -15.0°C |

Delta temp.set:

Variable frequency water pump speed adjustment target value of temperature difference between inlet and outlet water: the default is 5 degrees;

The output of the variable frequency water pump increases when the temperature difference between the inlet and outlet water is more than 5 degrees, and the output of the variable frequency pump decreases when the temperature difference between the inlet and outlet water is less than 5 degrees.

| | |
|-------------------------|--------------|
| Pump control | U08 |
| Delta temp. set: | 5.0°C |

Auto start:

Disable - when the heat pump is powered off, the heat pump will not automatically start;

Enable - the heat pump will automatically start after the heat pump is powered off

| | |
|-----------------------|---------------|
| User configure | U09 |
| Auto start: | Enable |

Enable Switch:

(With this function , the heat pump can do heating /cooling automatically based on the ambient temperature setting)

Enable Switch-Disable : turn off the automatic cooling/heating mode which is based on the ambient temperature; Original setting is Disable before delivery .

Enable Switch-Enable : turn on the automatic cooling/heating mode which is based on the ambient temperature.

AmbTemp Switch setp: Switch the ambient temperature setting point of the cooling/heating mode;

when the ambient temperature is lower than the set point-hysteresis, the unit will automatically switch to heating or hot water + heating;

when the ambient temperature is higher than the set point +In case of hysteresis, the unit will automatically switch to cooling or hot water+refrigeration;

when the ambient temperature is higher than the set point-hysteresis and lower than the set point + hysteresis maintains the current mode

Amb Temp.diff: The difference between the ambient temperature switching mode and the set temperature.

| | |
|-----------------------|------------|
| AmbTemp Switch | U10 |
| Enable Switch | Disable |
| AmbTemp Switch | |
| Setp.: | 20.0°C |
| Amb Tem.diff: | 4.0°C |





Eco. mode setting: On the following page, you can set different ambient temperature set points and water temperature settings in cooling, heating and hot water modes under Eco. mode; X is the set point of Ambient temperature and Y is the set point of water temperature.

| | | |
|-----------------------|------------|------------|
| Eco. mode-Cool | | U11 |
| Amb Temp. | Step. | |
| X1: 20.0°C | Y1: 15.0°C | |
| X2: 25.0°C | Y2: 15.0°C | |
| X3: 30.0°C | Y3: 12.0°C | |
| X4: 35.0°C | Y4: 12.0°C | |

| | | |
|-----------------------|------------|------------|
| Eco. mode-Heat | | U12 |
| Amb Temp. | Step. | |
| X1: -10.0°C | Y1: 45.0°C | |
| X2: 0.0°C | Y2: 40.0°C | |
| X3: 10.0°C | Y3: 40.0°C | |
| X4: 20.0°C | Y4: 35.0°C | |

| Eco. mode-Hotwater U13 | |
|------------------------|------------|
| Amb Temp. | Step. |
| X1: -10.0°C | Y1: 50.0°C |
| X2: 0.0°C | Y2: 50.0°C |
| X3: 20.0°C | Y3: 50.0°C |
| X4: 30.0°C | Y4: 45.0°C |

3、TimeZone/CLOCK

Press  to access menu, press  button to select TimeZone/CLOCK, then press  to confirm, Press  Button to change the setting, and press  to confirm.

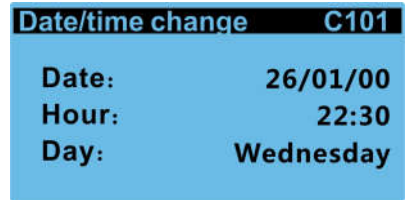

Timezone on off:

Enabl - Turn on the timer switch function, the unit can be set to switch on and off time for one week after it is switched on;

Disabl - Turn off the timer switch function.

Timezone setpoint:

Enabl - Turn on the timer temperature setting function, the unit can set different temperatures in four time periods of a day after it is turned on;

Disabl - Turn off the timer setting temperature function.

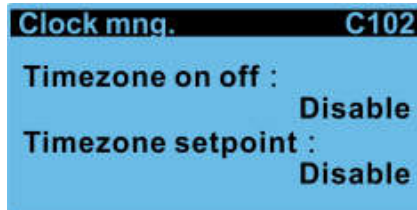

Timezone on off

Timing setting interface, under ON is the power-on time, and under OFF is the off-time.

| Clock mng. | | C103 |
|------------|-----|------|
| Timeband1 | | |
| | ON | OFF |
| Mon.: | 0:0 | 0:0 |
| Tue.: | 0:0 | 0:0 |
| Wed.: | 0:0 | 0:0 |
| Thu.: | 0:0 | 0:0 |

| Clock mng. | | C103-1 |
|------------|-----|--------|
| Timeband1 | | |
| | ON | OFF |
| Fri.: | 0:0 | 0:0 |
| Sat.: | 0:0 | 0:0 |
| Sun.: | 0:0 | 0:0 |

| Clock mng. | | C104 |
|------------|-----|------|
| Timeband2 | | |
| | ON | OFF |
| Mon.: | 0:0 | 0:0 |
| Tue.: | 0:0 | 0:0 |
| Wed.: | 0:0 | 0:0 |
| Thu.: | 0:0 | 0:0 |

| Clock mng. | | C104-1 |
|------------|-----|--------|
| Timeband2 | | |
| | ON | OFF |
| Fri.: | 0:0 | 0:0 |
| Sat.: | 0:0 | 0:0 |
| Sun.: | 0:0 | 0:0 |

Timezone setpoint Timing setting temperature interface;

Timezone1 is the start time of the first time period, **Timezong2** is the cut-off time of the first time period and the start time of the second time period, and so on.

Cooling temp、**Heating temp**、**Tank temp** Set the temperature for cooling, heating, and hot water for the corresponding time period



| Clock mng. | | C105 |
|----------------|-------|------|
| Timezone1: | 0:0 | |
| Cooling temp.: | 0.0°C | |
| Heating temp.: | 0.0°C | |
| Tank temp.: | 0.0°C | |

| Clock mng. | | C106 |
|----------------|-------|------|
| Timezone2: | 0:0 | |
| Cooling temp.: | 0.0°C | |
| Heating temp.: | 0.0°C | |
| Tank temp.: | 0.0°C | |

| Clock mng. | | C107 |
|----------------|-------|------|
| Timezone3: | 0:0 | |
| Cooling temp.: | 0.0°C | |
| Heating temp.: | 0.0°C | |
| Tank temp.: | 0.0°C | |

| Clock mng. | | C108 |
|----------------|-------|------|
| Timezone4: | 0:0 | |
| Cooling temp.: | 0.0°C | |
| Heating temp.: | 0.0°C | |
| Tank temp.: | 0.0°C | |

4、Input/Output



Press  to access menu, press \uparrow / \downarrow button to select I/O mask, then press  to confirm , Press \uparrow / \downarrow Button to see the I/O mask, E.g.c Water temperature/ Pressure/Frequency and so on.



| M02 | |
|--------------------------------------|--|
| Press ENTER to switch I/O mask | |



| Input/output Sn01 | |
|-------------------|------|
| B1: Inlet temp. | 40°C |
| B2: Outlet temp. | 45°C |
| B3: Ext temp. | 20°C |



| Input/output Sn02 | |
|----------------------|---------|
| B4: Disch. gas temp. | 80°C |
| B5: Suct. gas temp. | 13°C |
| B6: Disch. press. | 28.4bar |



| Input/output Sn03 | |
|--------------------|--------|
| B7: Suct. press. | 9.8bar |
| B8: Hotwater temp. | 55°C |
| B9: Coil temp. | 10°C |

| Input/output Sn05 | |
|-------------------------|---|
| Digit input status | |
| ID1: Flow switch |  |
| ID2: linkage switch |  |
| ID3: A/C linkage switch |  |

| Input/output Sn06 | |
|----------------------|--|
| Digit input status | |
| ID4: Cooling Linkage |  |
| ID5: Phase. switch |  |
| ID6: Heating linkage |  |

| Input/output Sn07 | |
|-----------------------|---|
| Digit . output status | |
| D01: Fan high speed |  |
| D02: Fan low speed |  |
| D03: 4 way valve |  |

| Input/output Sn08 | |
|-----------------------|--|
| Digit . output status | |
| D04: Pump |  |
| D05: Chassis heater |  |
| D06: Crank heater |  |

| Input/output Sn09 | |
|-----------------------|---|
| Digit . output status | |
| D07: Three valve |  |
| D08: Terminal Pump |  |
| D09: Heater |  |

| Input/output Sn10 | |
|-----------------------|------|
| Analog. output status | |
| Y1: fan output | 0.0% |
| Y3: Pump output | 0% |

Firmware version information query: Switch to the last page to query the firmware and software information of the controller

| Information | |
|--------------------|-------------------------|
| Code: | 1 2 5 |
| Ver.: | 6111 00 |
| Date: | CGK-060V2 2021.06.19 |
| OS: | 4.6.001 |

5、APP function

5.1 Device Homepage

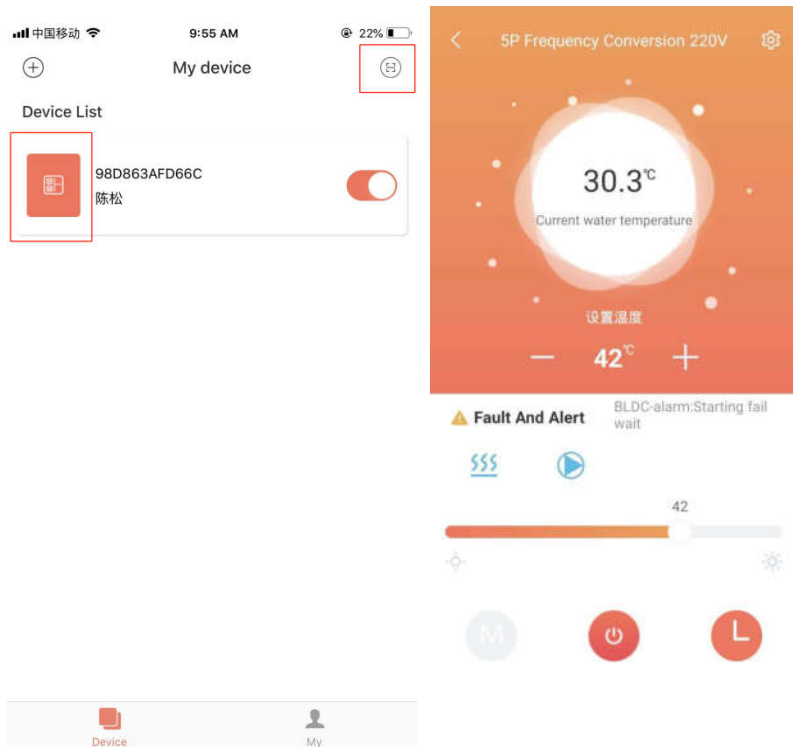

Explanation

- 1) Click a device in the device list to enter this page.
- 2) The background color of the bubble indicates the current operating state of the device:
 - a. Gray indicates that the device is in the shutdown state, at this time, you can change the working mode, set the mode temperature, set the timing, or you can press the key to switch on and off.
 - b. Multicolor indicates that the device is turned on, each working mode corresponds to a different color, orange indicates heating mode, red indicates hot water mode, and blue indicates cooling mode.
 - c. When the device is in the power-on state, you can set the mode

temperature, set the timer, press the key to switch on and off, but you can not set the working mode (that is, the working mode can only be set when the device is off)

- 3) The bubble shows the current temperature of the device.
- 4) Below the bubble is the set temperature of the device in the current operating mode.
- 5) Set the temperature is about **+**, **-** button , Each click adds or subtracts the current setting value to the device.
- 6) Below the setting temperature is the Fault And Alert. When the device starts to alarm, the specific Alert reason will be displayed next to the yellow warning icon. In case of device Fault And Alert, the Fault And Alert content will be displayed on the right side of this area. Click this area to jump to the detailed Error Information.

| AlarmResByBms | NONE | |
|------------------------|------|--|
| Too many mem writings | OK | |
| Retain mem write error | OK | |
| Inlet probe error | OK | |
| Outlet probe error | OK | |
| Ambient probe error | OK | |
| Condenser coil temp | OK | |
| Water flow switch | OK | |
| Phase sequ.prot.alarm | OK | |
| Unit work hour warning | OK | |
| Pump work hour warning | OK | |
| Comp.work hour warning | OK | |
| Cond.fan work hourWarn | OK | |
| Low superheat - Vlv.A | OK | |

- 7) Immediately below the fault alarm area, display the current working mode, heat pump, fan and compressor in sequence (corresponding blue icon when it is on, but not displayed when it is off).
- 8) The slide bar below is used to set the temperature in the current mode. Slide the slider left and right to set the allowable temperature in the current working mode.
- 9) The bottom three buttons are in order from left to right: working mode, device switching machine and device timing. When the current background is color, the working mode button cannot be clicked.
 - a. Click Work Mode to see the mode selection menu, and you can set the working mode of the device (black is the current setting mode of the device). The diagram as below:

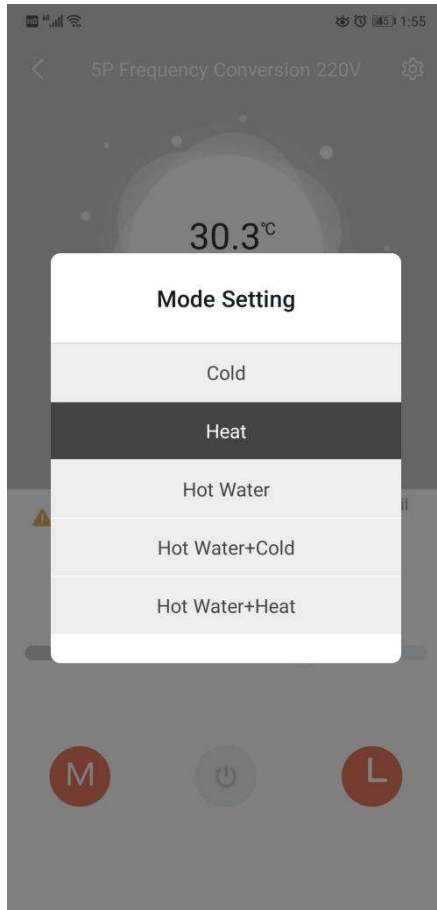

- b. Click "on/off" and set "on/off" command to the device.
- c. Click the device Timer to see the Timer Settings menu. Click the Clock Schedule to set the device Timer function. The diagram below:

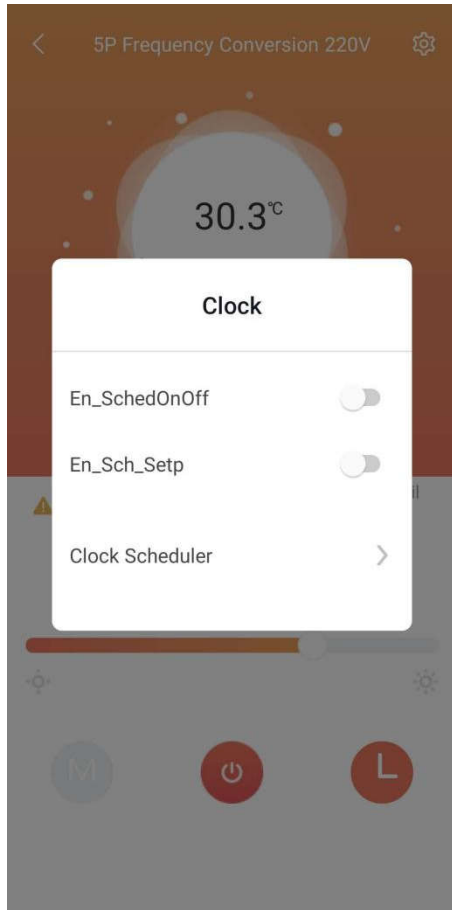















Detailed information of the units

Note :

- 1) Click this Main Interface menu on the upper right corner to enter this setting page.
- 2) Users with manufacturer rights can check all the functions , including:
User mask, defrost , other parm, factory settings, manual control , query parm, time edit, error info.

< Search Operation Name

| User Mask | Query Parm | TimeEdit | Error Info |
|---------------------|------------|----------|---|
| CoolHeat_Mode | Heat | |  |
| HeatSetP | 42.00 | |  |
| CoolSetP | 27.00 | |  |
| W_TankSetP | 52.00 | |  |
| Hotwater_start_diff | 5.00 | |  |
| Hotwater_stop_diff | 27.00 | |  |
| Temp_Diff | 5.00 | |  |
| Stop_Temp_Diff | 2.00 | |  |
| Kp | 5.00 | |  |
| Ti | 200 | |  |
| Td | 0 | |  |
| PmpMode | Setting | |  |
| FanMode_Sel | Day | |  |
| En_AuxHeat | N | |  |

3) User with user rights , only can check part of the functions: User mask, query parm, TimeEdit , alarms.

User setting parameter:

| Parameter Name | | Initial Value |
|--------------------------------|------------------|---------------|
| Unit mode | | Heating |
| Heating setp. | | 45°C |
| Cooling setp. | | 12°C |
| Hotwater setp. | | 50°C |
| Temp. diff. | | 5°C |
| Stop temp. diff. | | 0°C |
| Cool and heat mode Temp. diff. | | 5°C |
| Stop temp. diff. | | 2°C |
| Kp | | 5°C |
| Integral | | 200s |
| Differential | | 0s |
| Pump work | | Interval |
| Pump Auto | | Enable |
| Fan model | | Daytime |
| Enable heater | | Enable |
| Enable chassic/crack heater | | Enable |
| Heater control-Comp. delay | | 50min |
| Heater control-Ext.temp.setp. | | -15°C |
| Pump control | Delta temp. set. | 5°C |
| Auto start | | Enable |

Part 3. Maintenance and repairing

1、 Maintenance Tips

The heat pump unit is a highly automated equipment. The unit status check is carried out regularly during use. If the unit can be maintained and maintained for a long time and effectively, the unit's operational reliability and service life will be unexpectedly improved.

- 1、 Users should pay attention to the use and maintenance of this unit: all safety protection devices in the unit are set before leaving the factory, do not adjust by yourself;
- 2、 Always check whether the power supply and electrical system wiring of the unit is firm, whether the electrical components are malfunctioning, and if necessary, repair and replace them in time;
- 3、 Always check the water system's hydration, the water tank safety valve, the liquid level controller and the exhaust device to work properly, so as to avoid the air circulation into the system and reduce the water circulation, thus affecting the unit's heating capacity and unit operation reliability;
- 4、 The unit should be kept clean and dry and well ventilated. Regularly clean (1-2 months) air-side heat exchangers to maintain good heat transfer;
- 5、 Always check the operation of each component of the unit, check the oil pipe at the pipe joint and the gas valve, and ensure that the refrigerant of the unit is not leaking;
- 6、 Do not stack any debris around the unit to avoid blocking the air inlet and outlet. The unit should be clean and dry and well ventilated.
- 7、 If the downtime is long, the water in the unit piping should be drained, and the power supply should be cut off and the protective cover should be placed. When running again, check the system thoroughly before starting up;

- 8、 If the unit fails and the user cannot solve the problem, please inform the company's special maintenance department in order to send someone to repair it in time;
- 9、 The main unit condenser cleaning, the company recommends using a 50 ° C concentration of 15% hot oxalic acid to clean the condenser, start the host with a circulating water pump for 20 minutes, and finally rinse with tap water 3 times. (It is recommended to reserve a three-way interface when installing the pipe and seal one interface with a wire plug) in case of cleaning. Do not wash the condenser with a corrosive cleaning solution. The water tank needs to be removed after a period of use (usually two months, depending on local water quality).

2、 Error input and protection alarm

| | |
|-------|------------------------|
| AL001 | Too many mem writings |
| AL002 | Retain mem write error |
| AL003 | Inlet probe error |
| AL004 | Outlet probe error |
| AL005 | Ambient probe error |
| AL006 | Condenser coil temp |
| AL007 | Water flow switch |
| AL008 | Phase sequ.prot.alarm |
| AL009 | Unit work hour warning |
| AL010 | Pump work hour warning |
| AL011 | Comp.work hour warning |
| AL012 | Cond.fan work hourWarn |
| AL013 | Low superheat - Vlv.A |
| AL014 | Low superheat - Vlv.B |
| AL015 | LOP - Vlv.A |
| AL016 | LOP - Vlv.B |
| AL017 | MOP - Vlv.A |
| AL018 | MOP - Vlv.B |
| AL019 | Motor error - Vlv.A |
| AL020 | Motor error - Vlv.B |
| AL021 | Low suct.temp. - Vlv.A |
| AL022 | Low suct.temp. - Vlv.B |
| AL023 | High condens.temp.EVD |
| AL024 | Probe S1 error EVD |
| AL025 | Probe S2 error EVD |
| AL026 | Probe S3 error EVD |
| AL027 | Probe S4 error EVD |
| AL028 | Battery discharge EVD |

| | |
|-------|---------------------------------------|
| AL029 | EEPROM alarm EVD |
| AL030 | Incomplete closing EVD |
| AL031 | Emergency closing EVD |
| AL032 | FW not compatible EVD |
| AL033 | Config. error EVD |
| AL034 | EVD Driver offline |
| AL035 | BLDC-alarm:High startup DeltaP |
| AL036 | BLDC-alarm:Compressor shut off |
| AL037 | BLDC-alarm:Out of Envelope |
| AL038 | BLDC-alarm:Starting fail wait |
| AL039 | BLDC-alarm:Starting fail exceeded |
| AL040 | BLDC-alarm:Low delta pressure |
| AL041 | BLDC-alarm:High discharge gas temp |
| AL042 | Envelope-alarm:High compressor ratio |
| AL043 | Envelope-alarm:High discharge press. |
| AL044 | Envelope-alarm:High current |
| AL045 | Envelope-alarm:High suction pressure |
| AL046 | Envelope-alarm:Low compressor ratio |
| AL047 | Envelope-alarm:Low pressure diff. |
| AL048 | Envelope-alarm:Low discharge pressure |
| AL049 | Envelope-alarm:Low suction pressure |
| AL050 | Envelope-alarm:High discharge temp. |
| AL051 | Power+ alarm:01-Overcurrent |
| AL052 | Power+ alarm:02-Motor overload |
| AL053 | Power+ alarm:03-DCbus overvoltage |
| AL054 | Power+ alarm:04-DCbus undervoltage |
| AL055 | Power+ alarm:05-Drive overtemp. |
| AL056 | Power+ alarm:06-Drive undertemp. |
| AL057 | Power+ alarm:07-Overcurrent HW |
| AL058 | Power+ alarm:08-Motor overtemp. |
| AL059 | Power+ alarm:09-IGBT module error |
| AL060 | Power+ alarm:10-CPU error |

| | |
|-------|--|
| AL061 | Power+ alarm:11-Parameter default |
| AL062 | Power+ alarm:12-DCbus ripple |
| AL063 | Power+ alarm:13-Data comm. Fault |
| AL064 | Power+ alarm:14-Thermistor fault |
| AL065 | Power+ alarm:15-Autotuning fault |
| AL066 | Power+ alarm:16-Drive disabled |
| AL067 | Power+ alarm:17-Motor phase fault |
| AL068 | Power+ alarm:18-Internal fan fault |
| AL069 | Power+ alarm:19-Speed fault |
| AL070 | Power+ alarm:20-PFC module error |
| AL071 | Power+ alarm:21-PFC overvoltage |
| AL072 | Power+ alarm:22-PFC undervoltage |
| AL073 | Power+ alarm:23-STO DetectionError |
| AL074 | Power+ alarm:24-STO DetectionError |
| AL075 | Power+ alarm:25-Ground fault |
| AL076 | Power+ alarm:26-Internal error 1 |
| AL077 | Power+ alarm:27-Internal error 2 |
| AL078 | Power+ alarm:28-Drive overload |
| AL079 | Power+ alarm:29-uC safety fault |
| AL080 | Power+ alarm:98-Unexpected restart |
| AL081 | Power+ alarm:99-Unexpected stop |
| AL082 | Power+ safety alarm:01-Current meas.fault |
| AL083 | Power+ safety alarm:02-Current unbalanced |
| AL084 | Power+ safety alarm:03-Over current |
| AL085 | Power+ safety alarm:04-STO alarm |
| AL086 | Power+ safety alarm:05-STO hardware alarm |
| AL087 | Power+ safety alarm:06-PowerSupply missing |
| AL088 | Power+ safety alarm:07-HW fault cmd.buffer |
| AL089 | Power+ safety alarm:08-HW fault heater c. |
| AL090 | Power+ safety alarm:09-Data comm. Fault |
| AL091 | Power+ safety alarm:10-Compr. stall detect |
| AL092 | Power+ safety alarm:11-DCbus over current |

| | |
|-------|---|
| AL093 | Power+ safety alarm:12-HWF DCbus current |
| AL094 | Power+ safety alarm:13-DCbus voltage |
| AL095 | Power+ safety alarm:14-HWF DCbus voltage |
| AL096 | Power+ safety alarm:15-Input voltage |
| AL097 | Power+ safety alarm:16-HWF input voltage |
| AL098 | Power+ safety alarm:17-DCbus power alarm |
| AL099 | Power+ safety alarm:18-HWF power mismatch |
| AL100 | Power+ safety alarm:19-NTC over temp. |
| AL101 | Power+ safety alarm:20-NTC under temp. |
| AL102 | Power+ safety alarm:21-NTC fault |
| AL103 | Power+ safety alarm:22-HWF sync fault |
| AL104 | Power+ safety alarm:23-Invalid parameter |
| AL105 | Power+ safety alarm:24-FW fault |
| AL106 | Power+ safety alarm:25-HW fault |
| AL107 | Power+ safety alarm:26-reseved |
| AL108 | Power+ safety alarm:27-reseved |
| AL109 | Power+ safety alarm:28-reseved |
| AL110 | Power+ safety alarm:29-reseved |
| AL111 | Power+ safety alarm:30-reseved |
| AL112 | Power+ safety alarm:31-reseved |
| AL113 | Power+ safety alarm:32-reseved |
| AL114 | Power+ alarm:Power+ offline |
| AL115 | EEV alarm:Low superheat |
| AL116 | EEV alarm:LOP |
| AL117 | EEV alarm:MOP |
| AL118 | EEV alarm:High condens.temp. |
| AL119 | EEV alarm:Low suction temp. |
| AL120 | EEV alarm:Motor error |
| AL121 | EEV alarm:Self Tuning |
| AL122 | EEV alarm:Emergency closing |
| AL123 | EEV alarm:Temperature delta |
| AL124 | EEV alarm:Pressure delta |

| | |
|-------|------------------------------|
| AL125 | EEV alarm:Param.range error |
| AL126 | EEV alarm:ServicePosit% err |
| AL127 | EEV alarm:ValveID pin error |
| AL128 | Low press alarm |
| AL129 | High press alarm |
| AL130 | Disc.temp.probe error |
| AL131 | Suct.temp.probe error |
| AL132 | Disc.press.probe error |
| AL133 | Suct.press.probe error |
| AL134 | Tank temp.probe error |
| AL135 | EVI SuctT.probe error |
| AL136 | EVI SuctP.probe error |
| AL137 | Flow switch alarm |
| AL138 | High temp. alarm |
| AL139 | Low temp. alarm |
| AL140 | Temp.delta alarm |
| AL141 | EVI alarm:Param.range error |
| AL142 | EVI alarm:Low superheat |
| AL143 | EVI alarm:LOP |
| AL144 | EVI alarm:MOP |
| AL145 | EVI alarm:High condens.temp. |
| AL146 | EVI alarm:Low suction temp. |
| AL147 | EVI alarm:Motor error |
| AL148 | EVI alarm:Self Tuning |
| AL149 | EVI alarm:Emergency closing |
| AL150 | EVI alarm:ServicePosit% err |
| AL151 | EVI alarm:ValveID pin error |
| AL152 | Supply power error |
| AL153 | Fan1 fault |
| AL154 | Fan2 fault |
| AL155 | Fans Offline |
| AL165 | Slave1 Offline |

| | |
|-------|----------------|
| AL166 | Master Offline |
| AL167 | Slave2 Offline |
| AL168 | Slave3 Offline |
| AL169 | Slave4 Offline |
| AL170 | Slave5 Offline |
| AL171 | Slave6 Offline |
| AL172 | Slave7 Offline |
| AL173 | Slave8 Offline |
| AL174 | Slave9 Offline |

3、 Other problem and repairing

| No | Error | Possible reason | Method |
|----|-------------------------------|--|---|
| 1 | Heat pump doesn't run | <ol style="list-style-type: none"> 1. Power supply cable is loose 2. The fuse of power supply is fused. | <ol style="list-style-type: none"> 1. Cut off the power supply to check and repair. 2. Change the fuse. |
| 2 | Heating capacity is too small | <ol style="list-style-type: none"> 1. Refrigerant is not enough 2. Water system insulating is not good 3. Air heat exchanger is dirty 4. Water heat exchanger scaled | <ol style="list-style-type: none"> 1. Check leakage and repair and refill gas 2. Improve the insulation 3. Clean air heat exchanger 4. Clean water heat exchanger |
| 3 | Compressor doesn't run | <ol style="list-style-type: none"> 1. Power supply has error 2. Cable connecting is loose 3. Compressor is overheat | <ol style="list-style-type: none"> 1. Check reason and solve 2. Check loose and repair 3. Check reason and repair |
| 4 | Compressor noise is loud | <ol style="list-style-type: none"> 1. Expansion valve damaged lead to liquid entering compressor 2. The internal parts of compressor damaged 3. Compressor lack of oil | <ol style="list-style-type: none"> 1. Change expansion valve 2. Change compressor 3. Compensate oil for compressor |
| 5 | Fan motor doesn't run | <ol style="list-style-type: none"> 1. Fan blade fixing screw is loose 2. Fan motor damaged 3. Fan motor capacitance damaged | <ol style="list-style-type: none"> 1. Tight the screw 2. Change fan motor 3. Change the capacitance |
| 6 | Compressor run, but not heat | <ol style="list-style-type: none"> 1. There is not refrigerant at all 2. Compressor damaged | <ol style="list-style-type: none"> 1. Check leakage and repair 2. Change compressor |

Items of warranty:

1. Warranty terms: _____; Within warranty, any problem because of quality, please contact us for support.
2. When repair needed, please show the warranty card and invoice of order or other proof.
3. We don't afford the problem that is caused by re-fitment or adding other function by user.
4. Warranty card and invoice or other purchasing proof will be invalid if alerted.
5. Please keep the warranty card and invoice or other purchasing proofs well, we will need these for service purpose.
6. We will not provide free warranty for below conditions:
 - (1) without proof;
 - (2) errors caused by re-fitment or not correct operating;
 - (3) damage caused by not professional people operating;
 - (4) faulty by moving or falling;
 - (5) faulty caused by natural disaster;
 - (6) After the power failure, the water in the pipeline of the unit was not discharged, which caused the unit to freeze.

CERTIFICATE

Product Model:

Bar code:
