

---

# DC INVERTER Heat Pump

## User Manual

### Air to Water Heat

### Pump

### Heating+Cooling+DHW

#### Attention

*Thank you for choosing our product, we shall be more than glad to service you. For you to better operate this product and to prevent accidents due to misoperation, please read carefully this user manual before carrying out any installation or operation, also please pay special attention to the warning, prohibition and attention instructions. We are continuously supplementing and upgrading this user manual to better service for you!*

---

---

# Contents

Part 1. Before Use .....	2
❖ 1. Attentions.....	2
❖ 2. Installation instructions.....	4
❖ 3.R32 refrigerant introduction .....	6
❖ 4. Heat pump installation and wiring.....	17
❖ 5. Wiring diagram.....	21
Part 2. Use.....	23
❖ 1. Main interface.....	23
❖ 2.Dynamic graph .....	24
❖ 3.Turn ON/OFF .....	25
❖ 4.Mode switch.....	25
❖ 5.Temperature setting.....	26
❖ 6.Timer setting .....	27
❖ 7.Parameters query and setting.....	28
❖ 8.Current/historical alarm query .....	36
Part 3.Maintenance and repairing.....	37
Part 4.Warranty card .....	40

# Part 1. Before Use

## ❖ 1. Attentions



Warning



Caution



Prohibition

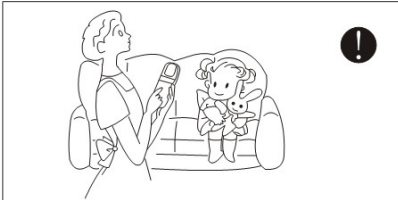

This appliance is not intended for use by persons, including children, with reduced physical, sensory or mental capabilities, or lack of experience and knowledge, unless they have been given supervision or instruction concerning use of the appliance by a person responsible for their safety. Children should be supervised to ensure that they do not play with the appliance.



Be sure to read this manual before use.

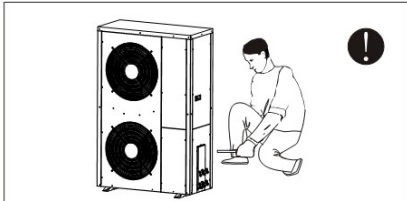

Be sure to read this manual before use. The installation, dismantling and maintenance of the unit must be performed by qualified personnel. It is forbidden to do any changes to the structure of the unit. Otherwise injury or person or unit damage might happen.

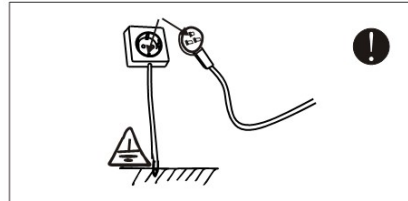

The power supply to the unit must be grounded.

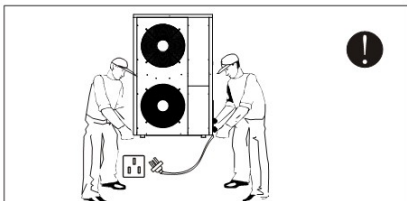

Make sure the power supply to the heat pump unit is off before any operations are done on the unit.

When the power cord gets loose or is damaged, always get



Keep the unit away from the combustible or corrosive environment.

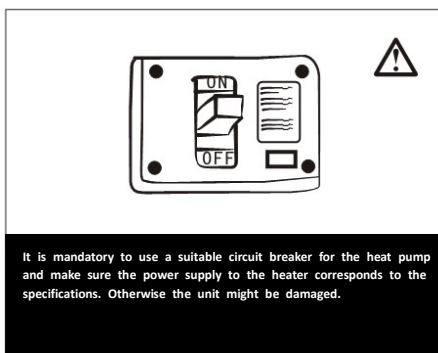
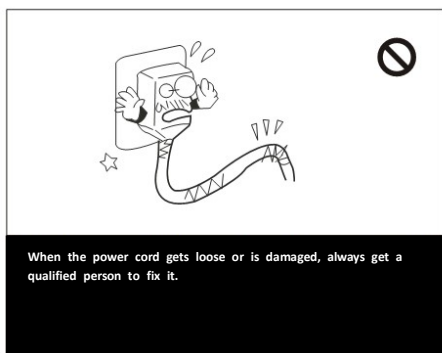
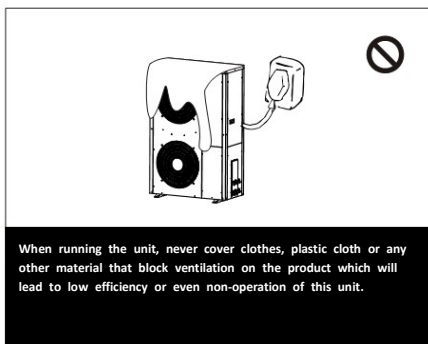
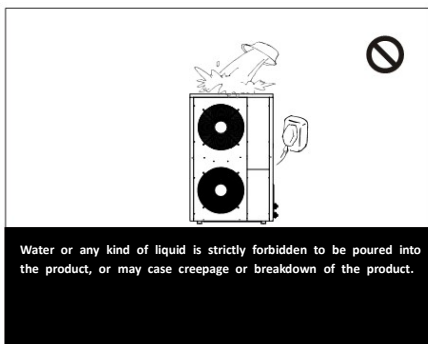
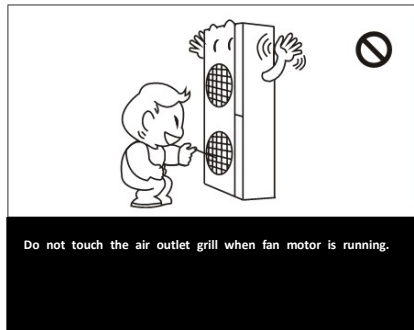
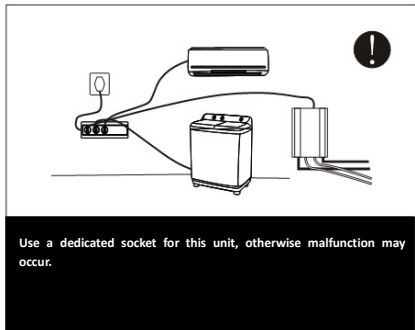

# Safety precaution

## ❖ 2. Installation instructions

1. Installation should comply with local regulations and requirements.
2. Choose a suitable space for use (please refer to indoor/outdoor unit location selection). The cooling capacity/heating capacity of the heat pump should be compatible with the size, height, and heat insulation effect of the room.
3. Before installation, be sure to confirm the neutral line, L, N, A phase, B phase, C phase, ground line of the user power supply and the neutral line of the heat pump, L, N, A phase, B phase, C phase, ground One correspondence.
4. This heat pump complies with the safety and operation standards issued by the country.
5. When the heat pump needs to be installed or moved. It must be operated by professional refrigeration installation and maintenance personnel. Heat pumps installed by non-professionals are prone to quality or safety problems.
6. The user should provide a power supply that satisfies the installation and use. The allowable range of voltage that can be used by this product is  $\pm 10\%$  of the rated value. If this range is exceeded, it will affect the normal operation of the heat pump. If necessary, use a voltage stabilizer to avoid property damage.
7. The heat pump must have an independent circuit. The independent

# Safety precaution

circuit needs to install a leakage protector and an automatic circuit breaker. Need to be purchased by the user.

8. The heat pump should be installed in accordance with the national wiring regulations.

9. The heat pump must be grounded correctly and reliably, otherwise it may cause electric shock or fire

10. Please do not turn on the power of the heat pump until the piping and wires are connected and carefully checked.

# Safety precaution

## ❖ 3.R32 refrigerant introduction

The heat pump uses environmentally friendly R32 refrigerant. This is a slightly flammable refrigerant. Although it can burn and explode under certain conditions, as long as it is installed in a room of the correct area and used correctly, there will be no danger of combustion and explosion. Compared with ordinary refrigerants, R32 is an environmentally friendly refrigerant that does not destroy the ozone layer, and its greenhouse effect value is also very low.

### **R32 heat pump room area requirements**

The area of the heat pump installation, operation and storage room should be larger than 4 square meters.



#### **Warning**

1. Please read this manual before installation, operate and maintenance.
2. Except as specifically recommended by the manufacturer, pls do not use any method to speed up the defrosting process or clean the frosted part.
3. Pls do not puncture or ignite the heat pump.
4. The heat pump should be stored in a room without a continuous fire



# Safety precaution

source (such as gas appliances ignited by an open flame, electric heaters, etc.).

5. When repairs are required, please contact the nearest after-sales service center. When repairing, you must strictly abide by the operation manual provided by the manufacturer, and it is forbidden to repair by non-professionals.
6. Pls comply with the relevant national gas laws and regulations.
7. The refrigerant in the system needs to be recovered and removed during maintenance or disposal.



## Repair of sealing elements

1. When repairing closed components, disconnect the power supply to the equipment before opening the sealed cover. If power supply is necessary during the maintenance process, continuous leak detection should be performed on the most dangerous parts to prevent potentially dangerous situations from happening.
2. In the following maintenance of electrical components, special care

# Safety precaution

should be taken not to affect the protection level of the enclosure. Improper maintenance methods may cause: damage to cables, excessive connections, terminals not installed according to the original regulations, damage to the seal, incorrect installation of the sealing cover and other dangers. Ensure that the installation of the equipment is safe and reliable. Ensure that the sealing or sealing material will not lose its function of preventing the entry of flammable gas due to aging. Replacement parts should meet the manufacturer's specifications.

Note: The use of silicon-containing sealants may reduce the detection capabilities of leak detection equipment. Intrinsically safe components do not need to be isolated before operation.

## **Maintenance of intrinsically safe components**

If it is not possible to ensure that the heat pump does not exceed the allowable voltage and current limits during use, do not use any permanent inductive or capacitive load in the circuit.

Intrinsically safe components are the only components that can continue to work in flammable gases. The test instrument should be set in the correct gear.

The replacement components can be only used the parts specified by the manufacturer, other parts may cause the refrigerant leaking in the air to catch fire.

## **Cable**

Check whether the cable will be affected by wear, corrosion,

# Safety precaution

overpressure, vibration, sharp edges or other adverse environments. The inspection should also consider the influence of aging or continuous vibration of the compressor and fan on the cable.

## **Leak inspection of R32 refrigerant**

Check for refrigerant leakage should be done in an environment where there is no potential ignition source. Halogen probes (or any other detectors that use open flames) should not be used for detection

## **Leak detection method**

For systems containing R32 refrigerant, an electronic leak detector can be used for testing. The test should be calibrated in a refrigerant-free environment to ensure that the leak detector does not become a potential source of ignition and is suitable for the refrigerant being tested. The leak detector should be set to the lowest flammable concentration of the refrigerant (expressed as a percentage), calibrated with the refrigerant used and adjusted to the appropriate gas concentration test range (up to 25%).

The fluid used to detect leaks is suitable for most refrigerants, but do not use chlorine-containing solvents to prevent chlorine and refrigerants from reacting and corroding copper pipes.

If a leak is suspected, all open flames should be removed from the scene or the fire should be extinguished.

# Safety precaution

If welding is required at the location where the leakage occurs, all refrigerants should be recovered, or all refrigerants should be isolated away from the leakage point (use shut-off valves). Oxygen-free nitrogen (OFN) is used to purify the entire system before and during welding.

## Remove and vacuum

Maintenance or other operations on the refrigeration circuit should be performed in accordance with normal procedures. However, the safety should also be considered, and the following procedures should be followed:

1. Remove refrigerant;
2. Purify the pipeline with inert gas;
3. Vacuum;
4. Purify the pipeline with inert gas again;
5. Cut the pipe or weld it.

The refrigerant should be recycled into a suitable storage tank. The system should be purged with oxygen-free nitrogen . This process may need to be repeated several times. Do not use compressed air or oxygen for this operation.

In the purging process, the system is filled with oxygen-free nitrogen to reach the working pressure under the vacuum state of the system, and then the oxygen-free nitrogen is discharged into the atmosphere, and finally the system is evacuated. Repeat this process until all refrigerant in the system is removed. After filling the oxygen-free nitrogen for the last time, exhaust the gas to atmospheric pressure, and then the system can be welded. The above operations are necessary for pipeline welding operations.

# Safety precaution

Ensure that there is no ignition source near the outlet of the vacuum pump and good ventilation.

## Procedure of refrigerant filling

As a supplement for the conventional procedures, the following requirements have been added:

1. Ensure that when using equipment of refrigerant filling, there will not be the mutual contamination between different refrigerants. The pipeline of refrigerant filling should be as short as possible to reduce the residual amount of refrigerant;
2. When filling refrigerant, there should be without the fire source near the unit;
3. Make sure that the refrigerant system has taken grounding measures before charging the refrigerant;
4. After filling refrigerant (or not finished), stick the label on the system;
5. Must be careful not excessive filling;

Perform a pressure test with oxygen-free nitrogen before refilling refrigerant into the system. After filling, a leak test must be carried out before the trial operation. The leak test must be carried out again when leaving the area.

## Scrapping

Before proceeding with this procedure, the technician should be fully familiar with the equipment and all of its characteristics. It is recommended to recover safe refrigerant. If it is necessary to re-use the recovered refrigerant, samples of refrigerant and oil should be analyzed before operation. Before testing, please ensure that you have got the required power source.

# Safety precaution

Being familiar with the equipment and its operation;

2. Disconnecting the power supply;

3. Before proceeding with this procedure making sure that:

☐ If necessary, the equipment of mechanical operation should be convenient to operate the refrigerant storage tank;

☐ All personal protective equipment are effective and can be used correctly;

☐ The entire recycling process should be carried out under the guidance of qualified persons;

Recycling equipment and refrigerant storage tanks should meet the corresponding standards.

## Maintenance safety matters

### Warning

1. For repairs or scrapping, please contact the nearest or authorized service center.

2. Repairs performed by unqualified personnel may be dangerous.

3. When charging the heat pump with R32 refrigerant and maintaining it, please strictly observe the manufacturer's requirements. This chapter mainly focuses on the special maintenance requirements of R32 refrigeration appliances. Please refer to the after-sales service manual for detailed maintenance operations.

## Qualification requirements for maintenance personnel

# Safety precaution

1. All operating personnel or refrigeration circuit maintenance personnel should obtain a valid certificate issued by an industry-recognized evaluation agency to determine that they have the qualifications for safe handling of refrigerants as required by the industry-recognized evaluation specifications.
2. The maintenance and repair of the equipment can only be carried out in accordance with the method recommended by the equipment manufacturer. If other professionals are required to assist in maintaining and repairing the equipment, it should be carried out under the supervision of personnel qualified to use flammable refrigerants.

## Site inspection

Before repairing heat pumps using R32 refrigerant, safety inspections must be carried out to ensure that the risk of fire is minimized. When servicing the refrigeration system, the following precautions should be observed before handling the system.

## Operational procedure

Operations should be carried out under a controlled procedure to ensure that the risk from combustible gases or vapors is minimal during operations.

### General operating area

All maintenance people and other people in the operation area should be aware of the character of the operation being performed. Avoid working in confined Spaces. Work areas should be properly isolated to ensure safe working conditions within the work area by controlling combustible materials.

# Safety precaution

## Check whether the refrigerant is present

Refrigerant monitors are necessary to be used in the area before and during operations to ensure that technicians are aware of the presence of potentially combustible gases. Ensure that the leak detection equipment used is suitable for R32 refrigerants, such as sparkless, fully sealed, or intrinsically safe.

### Placement of fire extinguishers

The applicable fire extinguisher should be located close to the cooling system or related components during hot working operations. The refrigerant injection area should be equipped with dry powder or carbon dioxide fire extinguisher.

## No fire

Any fire sources should not be used when performing work related to exposed pipes that hold or have held R32 refrigerant which may cause a fire or explosion hazard. All sources of fire, including smoking, should be kept away from the area of installation, repair, removal and disposal of combustible refrigerants that may release into the surrounding environment. Before starting operations, check the environment around the equipment to ensure that there is no danger of flammability or fire. There should be a "no smoking" sign.

## Ventilated area

Ensure that the work area is open or fully ventilated before opening the system or performing thermal processing operations. Keep ventilation during operation. Ventilation will safely dilute the leaked refrigerant and quickly discharge it into the atmosphere.

## Inspection of refrigeration equipment



# Safety precaution

If the electrical components are replaced, these electrical components should be installed in accordance with the purpose of use and correct operation regulations. At all times, you should follow the manufacturer's maintenance and repair guidelines. If you have any questions, please consult the manufacturer's technical department. For installations using R32 refrigerant heat pumps, the following inspection items apply:

1. The filling amount should be determined according to the marked amount on the heat pump's rating plate.
2. The ventilation equipment should operate normally, and the vents should be unobstructed.
3. If an indirect refrigeration cycle is used, please check whether there is refrigerant in the secondary circuit.
4. The logo or marking on the heat pump should be clearly visible, and the ambiguous signs and symbols should be corrected;
5. Refrigeration piping or electrical components should not be installed in an environment that contains components that may be corrosive to contact the refrigerant, unless the electrical components themselves are made of anti-corrosion materials or take appropriate anti-corrosion measures.



- a. To avoid electrical shock, make sure to disconnect power supply 1 minute or more before operating the electrical part. Even after 1 minute, always measure the voltage at the terminals of main circuit capacitors or electrical parts and, before touching, make sure that those voltages are

# Safety precaution

- lower than the safety voltage.
- b. Power supply wire line size must be selected according to this manual. And must be grounded.
  - c. Don't put in hands or stick to air outlet grill when fan motor are working.
  - d. Don't use wet hand touch wire lines, and don't pull any wire lines of the unit.
  - e. Water or any other kind liquid is forbidden to poured into the unit.
  - f. Select correct air breaker and leakage protection switch.
  - g. Don't touch the fin of source side heat exchanger, it may hurt your finger.
  - h. If any wire line is loose or damaged, suggest let qualified person to fix i

## ❖ 4. Heat pump installation and wiring

### (1) Heat pump installation location and attentions

- \* Heat pump is not allowed to be installed in the place where combustible gas may leaks.
- \* Heat pump is not allowed to be installed in the place where there is oil or corrosion gas released.
- \* Heat pump should be installed in a open space, and good ventilating.
- \* Heat pump each side to wall or barrel should be keep certain distance, air outlet to barrel distance should  $\geq 2m$ , air inlet distance to wall or barrel  $\geq 0.5m$ , bottom distance to ground  $\geq 0.2m$ , other side distance should be enough for installation or repairing.
- \* Heat pump should be installed on concrete basic or steel bracket, and anti-shock pad should be put between heat pump and basic or bracket. Then use expansion bolt to fix heat pump on bracket.
- \* Water drainage pipe and ditch should be set around heat pump and water pipes and water tank. When testing or repairing, maybe need drain plenty of water, and when heat pump is working, there are some condensed water flow down.

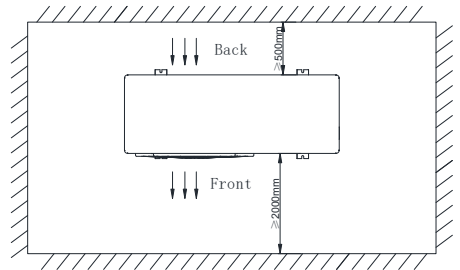
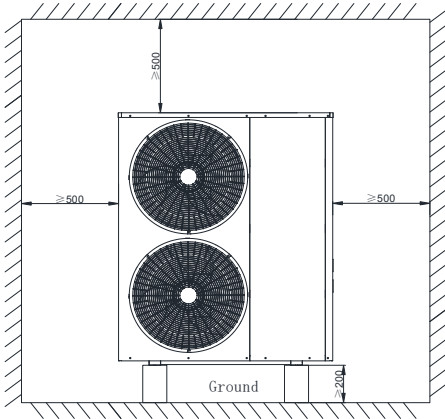

## (2)Primary circulation system

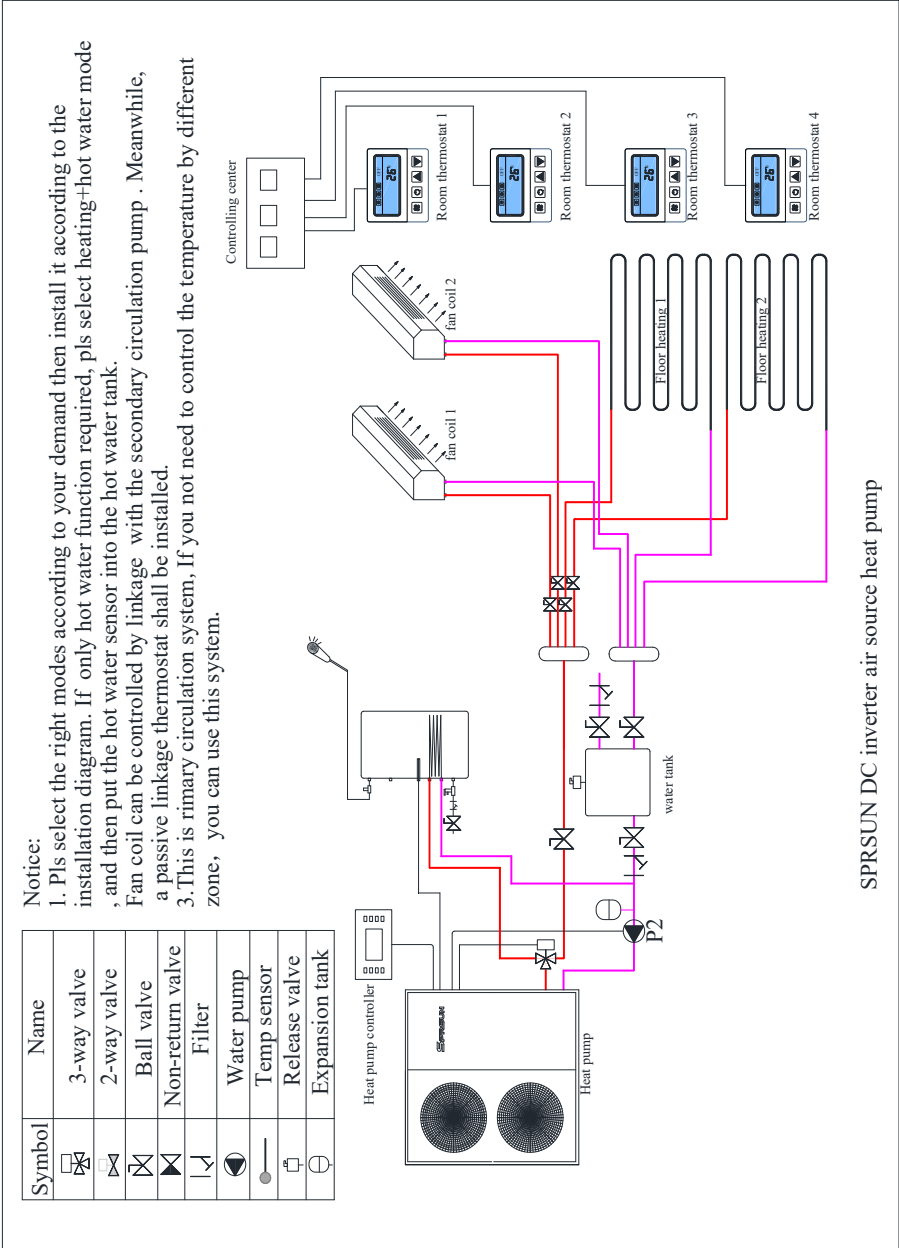

# Secondary circulation system

**Notice:**

1. Pls select the right modes according to your demand then install it according to the installation diagram. If only hot water function required, pls select heating+hot water mode , and then put the hot water sensor into the hot water tank.
2. Two-way valve and BV valve are optional for installation. Only if you need to control the temperature by different zone, then pls install both.
3. Fan coil can be controlled by linkage with the secondary circulation pump . Meanwhile, a passive linkage thermostat shall be installed.

Symbol	Name
	3-way valve
	2-way valve
	Ball valve
	Non-return valve
	Filter
	Water pump
	Temp sensor
	Release valve
	Expansion tank

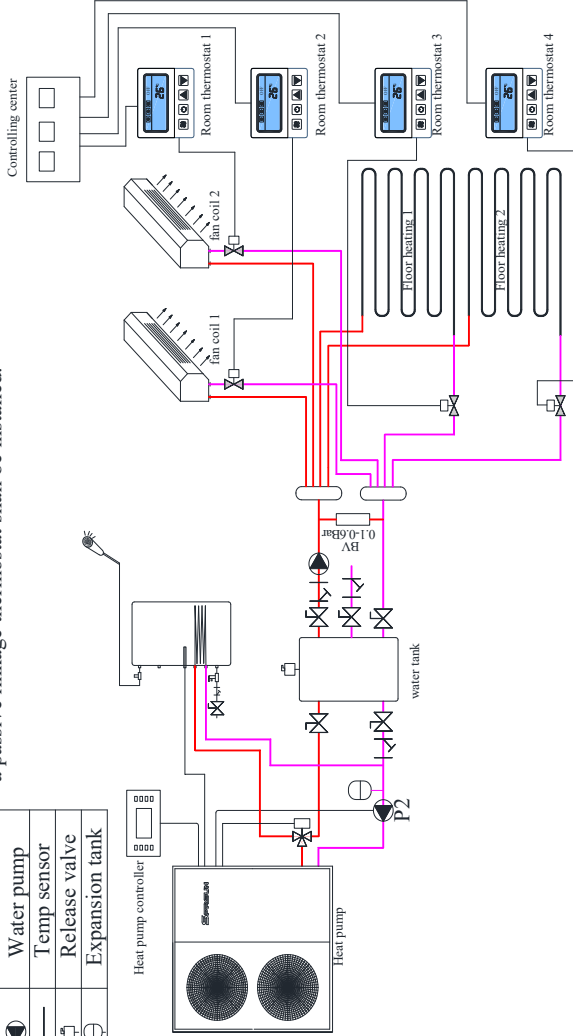

SPRSUN DC inverter air source heat pump

## Tips for installation related to the water pipe part:

- Install a valve at the highest point of each water circulations for releasing air from water system.
- A Y-shape filter is very important in front of circulating water pump of heat pump.
- If more pieces heat pump installed in one water pipe system, the connection of these heat pumps can't be in series, only can be in parallel or independent.

### (3) Pre-start up

#### ① Checking before pre-start up

- Check if the water pipe are connected well and if there is any leakage. The water supply valve are open.
- Make sure the water flow is enough and meet the demand of the heat pump selected and water flow smoothly without air . In cold area, pls make sure that the water flow is without freezing
- Check if the power cable is connected well and properly grounded.
- Check if fan blade is blocked by the fixing plate of fan blade and fan blade protecting grill.
- Check if the tank has been filled with water or enough water volume that can meet the demand of heat pump running



If everything above is OK, the unit can start up. If any of them fails, please improve it.

#### ② Pre-start up

- After check completely and confirm no problem for installation, the unit can be power to start up .
- After connect power supply, heat pump delay 3mins to start. Check carefully is there is some abnormal noise or vibration or if the working current is normal or if water temp increasing is normal.
- After the unit is working properly for 10 minutes without any problem, then the pre-start up is usefully completed. If not, pls refer to Service and Maintenance

# Wiring diagram

## ❖ 5. Wiring diagram

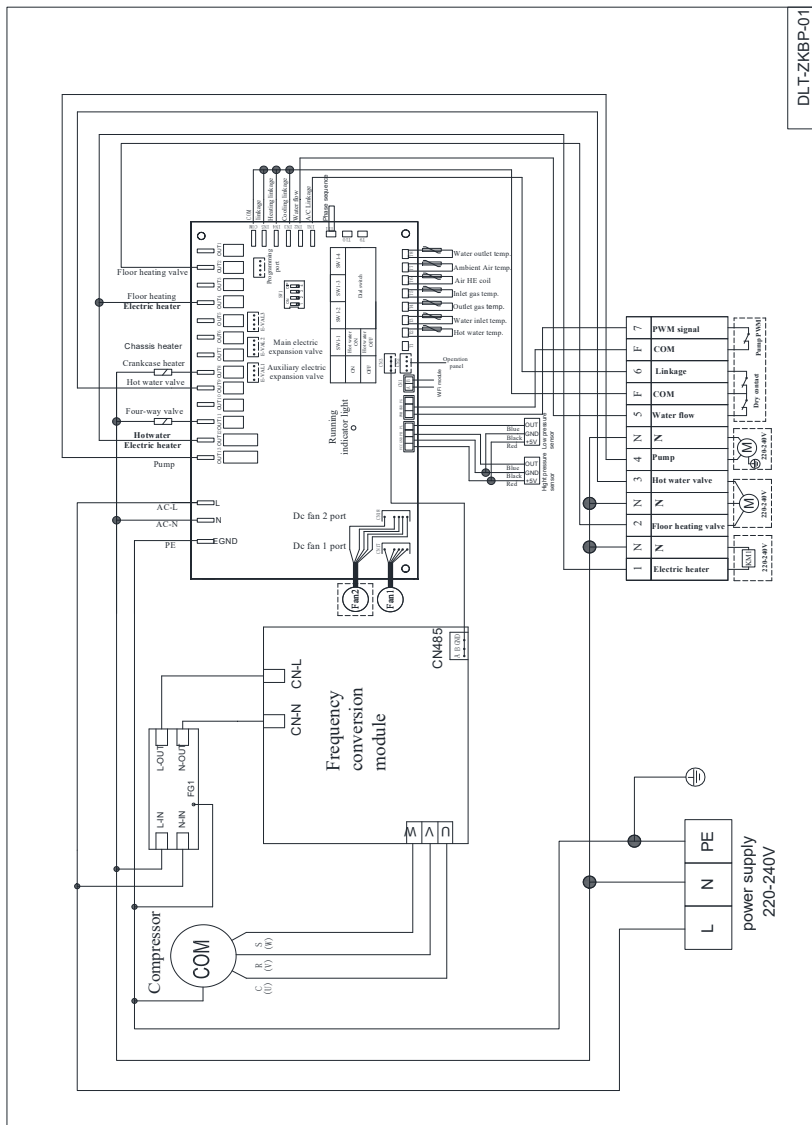

DLT-ZKBP-01

Voltage: 220V~240V/50Hz or 60 Hz/1Ph

# Terminals

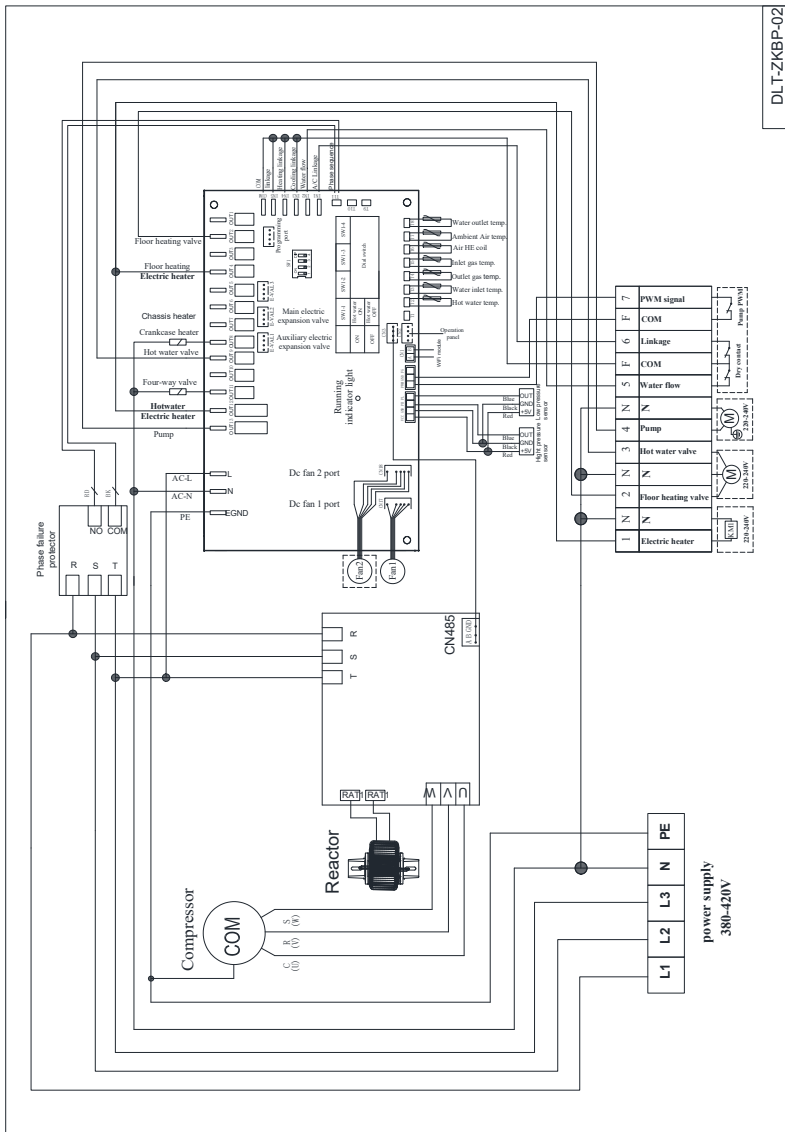

DLT-ZKBP-02

Voltage: 380V ~ 420V/3/50Hz or 60 Hz



## Part 2. Use

### ❖ 1. Main interface ( simple graphic )

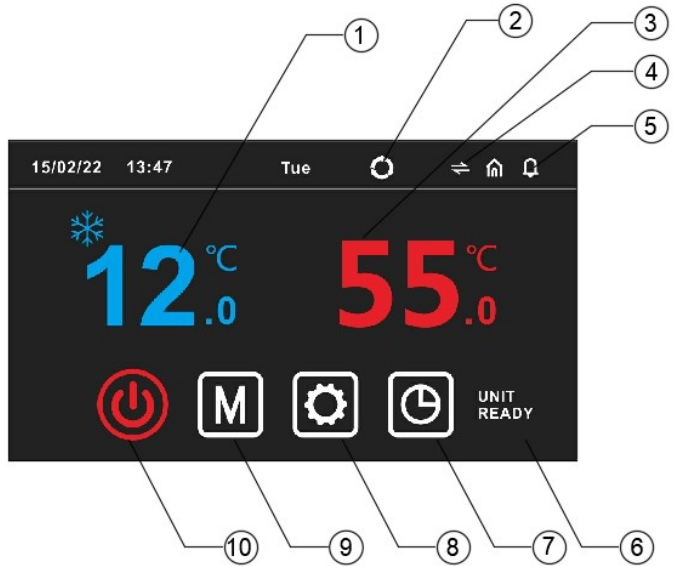



① Heating / Cooling temperature display :







Displays the current cooling real-time temperature in blue



font. Displays the current real-time heating temperature in orange font.

In the upper left corner of the temperature display, when there is  or  icon, it indicates that the unit is running the cooling or heating mode.

② Displays the fan mode of the current unit:  indicates day mode;  indicates night mode;  indicates economic mode;  indicates test mode.

③ Hot water temperature display:





Displays the current hot water temperature in red font. In the upper

left corner of the temperature display, when there is  icon, it indicates that the unit is running the hot water mode.

④ Simple graph and dynamic graph switching: Click the  icon to switch between simple graph and dynamic graph.

⑤ Click  to check the current fault alarms and historical fault alarms.

⑥ The display of heat pump status on the right below corner : The running status of heat pump is displayed here

⑦ Timing setting: Click  to enter into timing setting ; in red when there is a timing, , in white when there is no timing, .

⑧ System parameter setting: Click this icon to enter the setting interface.

⑨ Mode setting: Click this icon to enter the mode setting interface.

⑩ Power on and off: Click the icon to operate the power on and off.。



shows red when it is turned on, and



shows white when it is turned off.

## ❖ 2. Dynamic graph



Hot water tank temperature

② Hot water setting temperature. Click here to enter the temperature setting

③ Current working mode,  is Cooling mode,  is heating mode



- ④ Current cooling/heating temperature. When the current mode is cooling mode, display the current cooling temperature. When the current temperature is in heating mode, the current heating temperature is displayed.
- ⑤ Cooling/heating setting temperature, click here to enter the temperature setting
- ⑥ Click the unit icon to set the power on/off.

❖ **3. Turn ON/OFF**

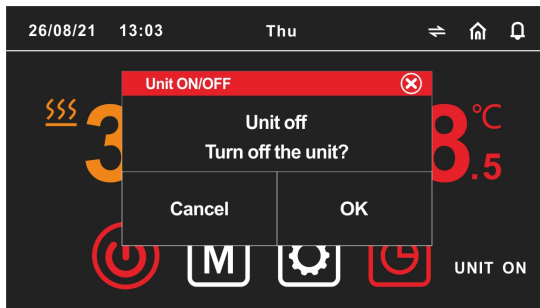
- Click  to set the unit on/off. If the iron is in white color , it means that the current unit is off. And if icon is in red color , it means that current unit is on.



❖ **4.Mode switch**

- Click  to set the unit mode. After selecting the required mode, click  to confirm, and click  to Cancel and exit the page.

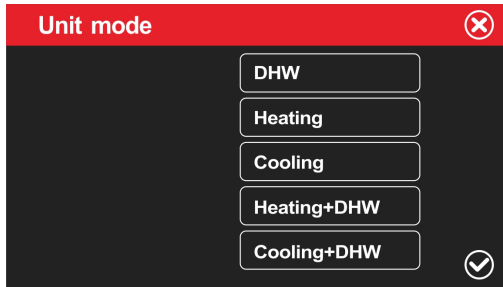

- 5. · Temperature setting
- · Click the ①② position of the real-time temperature to enter the temperature setting interface.

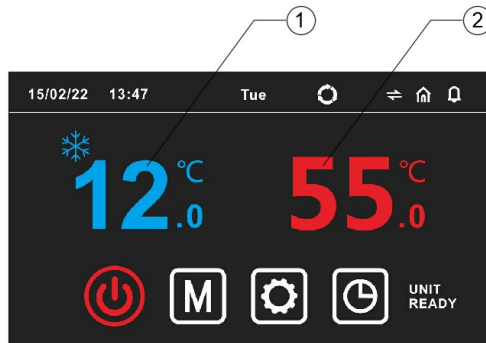

- **Set the temperature and hysteresis of each mode in the temperature setting interface.**

Setpoint	
Heating setp.	45°C
Cooling setp.	12°C
Temp. diff.	5°C
Hotwater setp.	50°C
Temp. diff.	5°C

Cooling setp. : Cooling stop temperature setting

Heating setp. : Heating stop temperature setting

Temp. Diff. : when running heating/cooling mode,The difference between the unit's

shutdown temperature and the set temperature after reaching the setting temperature.

Hotwater setp . : Hot water tank temperature stop temperature setting

Temp. Diff. : when running hot water mode,The difference between the unit's shutdown temperature and the set temperature after reaching the setting temperature.

## ❖ 6.Timer setting



- Press the  button to pop up the timing control interface, and set the timing in the timing control interface.

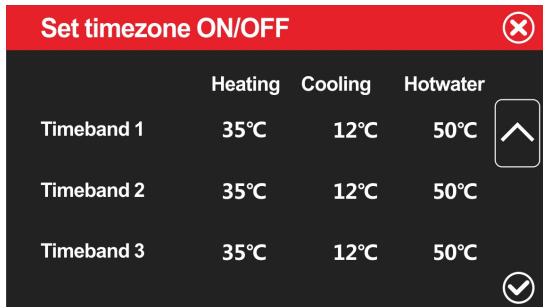

Timing period is not enabled/enabled: the switch is left when not enabled ,

and the switch is right when enabled 

ON: Set for the timing power-on time.

OFF: Set for timing off time.

Timeband1/2/3, means that there are three timings that can be set, and each timing can set different hot water, heating and cooling temperatures.

## ❖ 7.Parameters query and setting

➤ Press  to Main Menu as below :

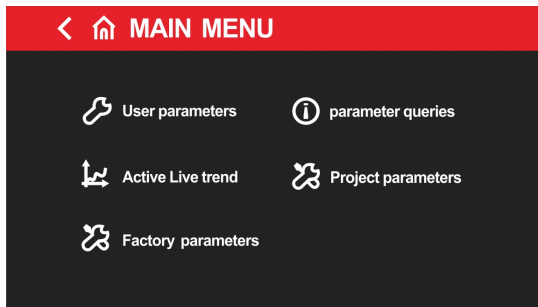

① User Parameters : Press  **User parameters** for user parameter setting

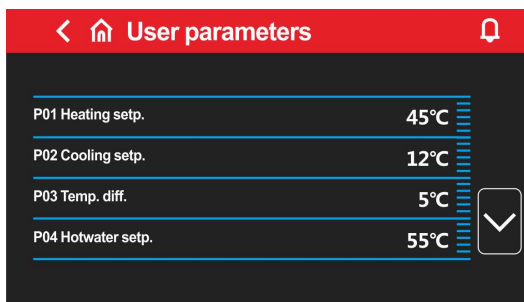

P01 Heating setp. : Heating shutdown temperature

P02 Cooling setp. : Cooling shutdown temperature

P03 Temp. Diff. : The difference between the unit's shutdown temperature and the setting temperature after reaching the setting temperature.

P04 Hotwater setp. : Hotwater heating shutdown temperature.

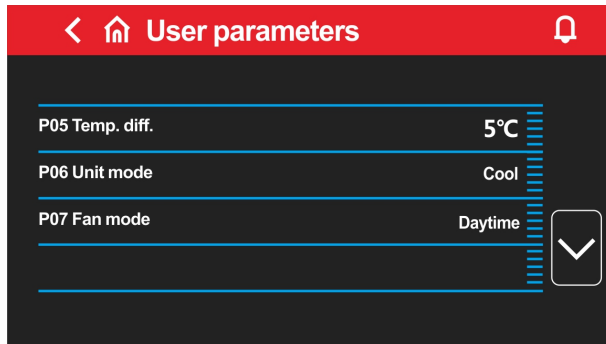

P05 Temp. Diff. : When the machine is operating hot water mode, the difference between the unit's shutdown temperature and the set temperature after reaching the setting temperature.

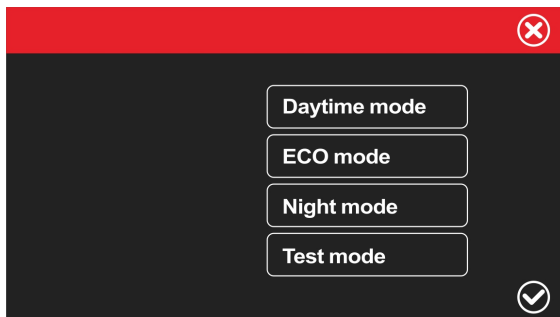

P06 Unit mode: Modes choice of heat pumps.

P07 Fan mode: Modes choice of fans. Day Mode, Economic Mode, Testing Mode and Night Mode are optional.

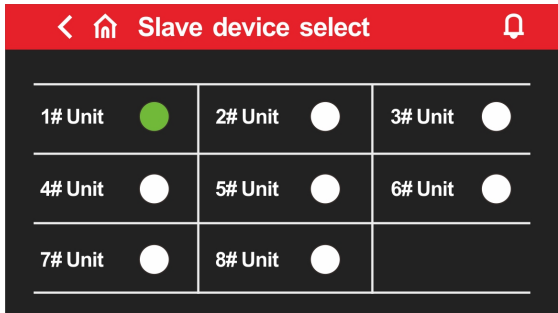

② Parameter query: Click  you can check the operating parameters.



When a single unit is running, the 1# Unit icon is to the right , click 1# unit to query the operating parameters of the 1# unit; if there is a linkage network, you can click 2#, 3#...8# to query the operating parameters of the corresponding unit, and the software version number. If the unit icon is displayed , the unit is not connected.

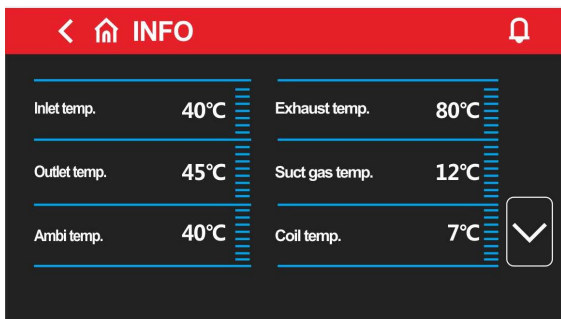



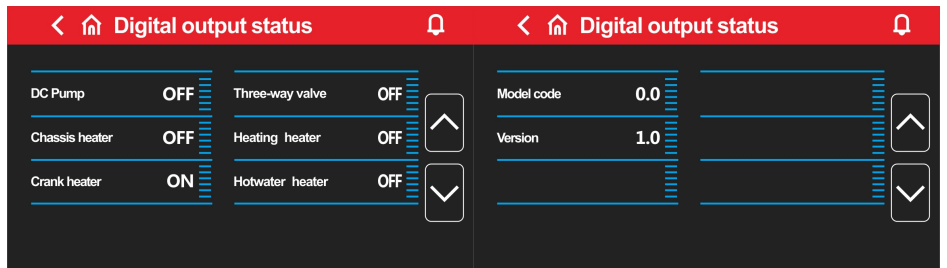
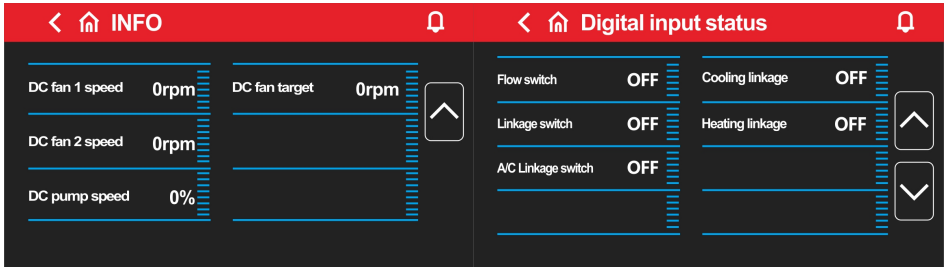
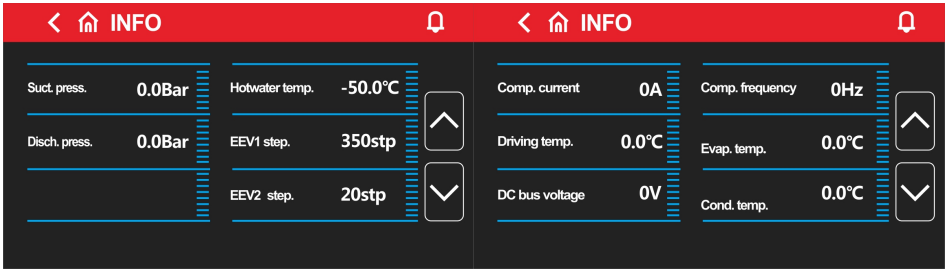

③ Press this  **Active Live trend** can check the curves of heating temperature, outlet water temperature, and hot water tank temperature changing with running time

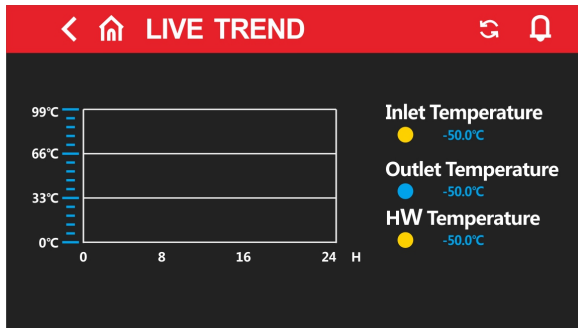

## Project parameters

④ Engineering parameters: click here [Project parameters](#) and enter the password to set the engineering parameter. This password is only provide for the construction contractor, if needed, please contact our engineers, it can be operated after receiving our authorization.

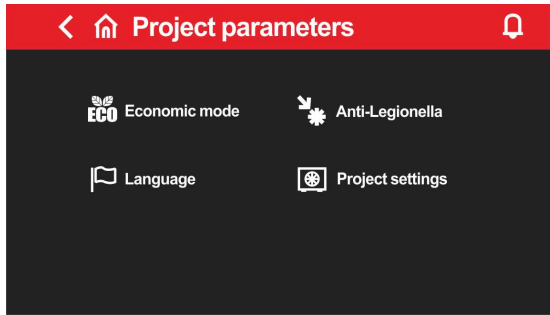

## Economic mode

Click [Economic mode](#) can enter the setting of relevant parameter on ECO mode

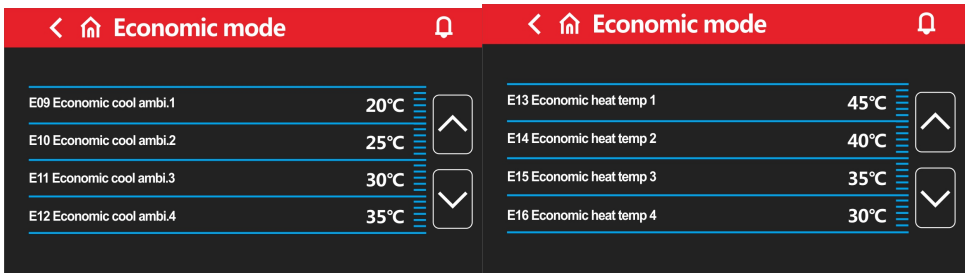
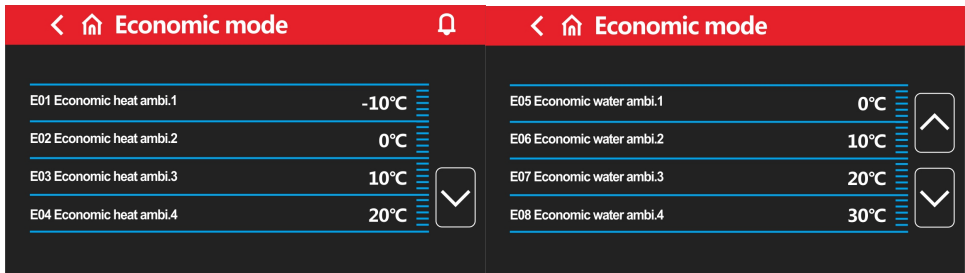

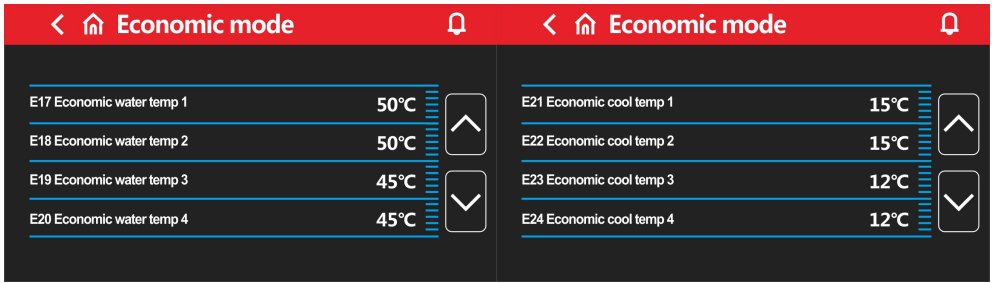

Click  **Anti-Legionella** can enter Relevant parameter settings for high temperature sterilization mode.

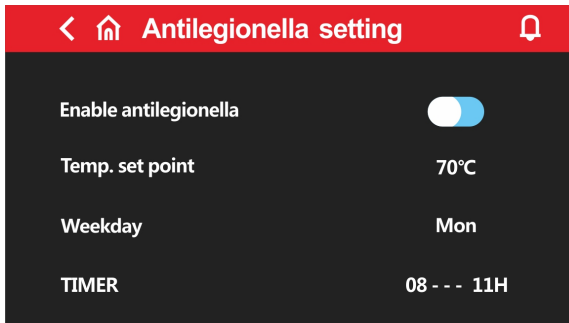



Enable antilegionella: Disable or enable sterilization function, right is enable .

Temp. Setpoint: Sterilization temperature setting;

Weekday: Sterilization work days, once a week;

TIMER: Sterilization time point, once a week;

Press  **Language** to enter the language selection interface;

Press  **Project settings** to access the relevant settings of project parameters

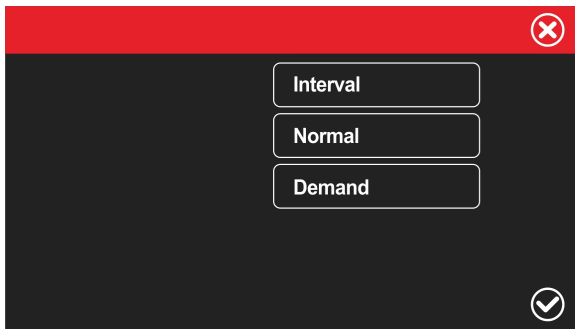
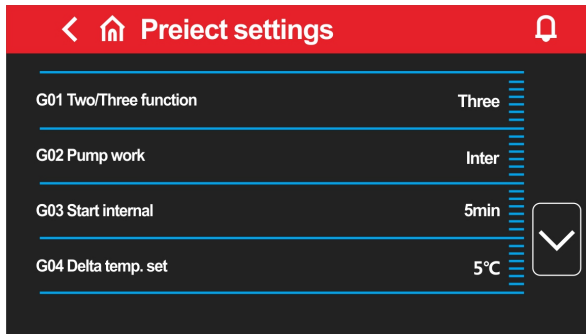

Two/Three function :Click "two" and "three" to select whether the current unit is double supply or triple supply;

DC Pump work: The working mode of the inverter water pump can be selected as demand, always on, intermittently on;

Start internal: The interval time for the start of the inverter water pump in intermittent mode;

Delta temp. set: The inverter water pump controls the current temperature difference between the incoming and outgoing water;

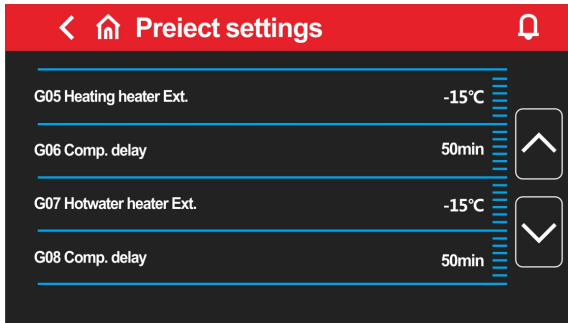

Heating heater Ext.: Start-up ambient temperature of heating electric heater;  
 Comp. Delay: heating electric heater start delay;

Hotwater heater Ext.: Start-up ambient temperature of hot water electric heater;  
 Comp. Delay: Hot water electric heater start delay;

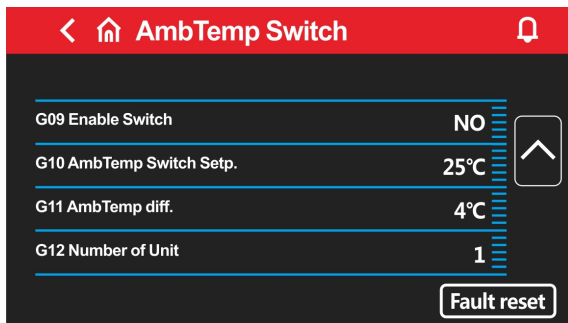

Enable Switch:

(With this function , the heat pump can do heating /cooling automatically based on the ambient temperature setting )

Enable Switch -No : turn off the automatic cooling/heating mode which is based on the ambient temperature; Original setting is Disable before delivery .

Enable Switch-Yes : turn on the automatic cooling/heating mode which is based on the ambient temperature.

AmbTemp Switch setp.: Switch the ambient temperature setting point of the cooling/heating mode;

when the ambient temperature is lower than the set point-hysteresis, the unit will automatically switch to heating or hot water + heating;

when the ambient temperature is higher than the set point +In case of hysteresis, the

unit will automatically switch to cooling or hot water+refrigeration;  
 when the ambient temperature is higher than the set point-hysteresis and lower than  
 the set point + hysteresis maintains the current mode  
 Amb Temp.diff: The difference between the ambient temperature switching mode and  
 the set temperature.

Number of Unit:

When the units are networked and the operating parameters of multiple units need to  
 be queried, select the corresponding number of units

Fault reset:

Reset current fault

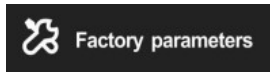

⑤ Factory parameters: Press here and enter the password to  
 query and set the factory parameters, this password needs to contact the technical  
 engineer, and the operation can only be done after authorization.

❖ 8. Current/historical alarm query



➤ The flashing icon in the upper right corner indicates that there is an  
 alarm. Press this icon to pop up the current alarm interface.

HISTORY ALARMS	
Time	Description
15/02/22 14:01	#01 E67 Low press sensor failure
15/02/22 14:01	#01 E68 High press sensor failure
15/02/22 14:01	#01 E42 Cool coil TP failure
15/02/22 14:01	#01 E29 Return TP failure
15/02/22 14:01	#01 E63 Eco outlet TP failure
15/02/22 14:01	#01 E62 Eco inlet TP failure

➤ Press  to show a dialog box for whether to delete historical alarms,  
 press "YES" to delete historical alarms, and press "NO" to cancel the  
 operation.

➤ Press  to switch between current alarm and historical alarm.

➤ Press  to return to main menu.

## Part 3.Maintenance and repairing

### 1、 Error input and protection alarm

Error code	Error description
Er 02	Lack of phase
Er 03	Water flow failure
Er 04	Antifreeze in winter
Er 05	High pressure fault
Er 09	Communication failure
Er 10	Communication failure of frequency conversion module (alarm when communication between outer board and drive board is disconnected)
Er 12	Exhaust temp too high protection
Er 14	Water tank temperature sensor fault
Er 15	Water inlet temperature sensor fault
Er 16	Evaporator coil temperature sensor fault
Er 18	Exhaust temperature fault
Er 20	Abnormal protection of frequency conversion module
Er 21	Ambient temperature sensor fault
Er 23	Cooling outlet water temperature supercooling protection
Er 26	Heat sink temperature fault
Er 27	Outlet water temperature sensor fault

Er 29	Return gas temperature sensor fault
Er 32	Heating too high outlet water temperature protection
Er 33	Coil temperature too high
Er 34	The temperature of frequency conversion module is too high
Er 42	Cooling coil temperature sensor failure
Er 62	Inlet temperature fault of economizer
Er 44	Air temp too low
Er 63	Outlet temperature failure of economizer
Er 64	DC fan 1 fault
Er 66	DC fan 2 fault
Er 67	Low pressure switch failure
Er 68	High pressure switch failure
Er 69	Too low pressure protection
Er 70	Too high pressure protection

## **2、 Other problem and repairing**



No	Error	Possible reason	Method
1	Heat pump doesn't run	<ol style="list-style-type: none"> <li>1. Power supply cable is loose</li> <li>2. The fuse of power supply is fused.</li> </ol>	<ol style="list-style-type: none"> <li>1. Cut off the power supply to check and repair.</li> <li>2. Change the fuse.</li> </ol>
2	Heating capacity is too small	<ol style="list-style-type: none"> <li>1. Refrigerant is not enough</li> <li>2. Water system insulating is not good</li> <li>3. Air heat exchanger is dirty</li> <li>4. Water heat exchanger scaled</li> </ol>	<ol style="list-style-type: none"> <li>1. Check leakage and repair and refill gas</li> <li>2. Improve the insulation</li> <li>3. Clean air heat exchanger</li> <li>4. Clean water heat exchanger</li> </ol>
3	Compressor doesn't run	<ol style="list-style-type: none"> <li>1. Power supply has error</li> <li>2. Cable connecting is loose</li> <li>3. Compressor is overheat</li> </ol>	<ol style="list-style-type: none"> <li>1. Check reason and solve</li> <li>2. Check loose and repair</li> <li>3. Check reason and repair</li> </ol>
4	Compressor noise is loud	<ol style="list-style-type: none"> <li>1. Expansion valve damaged lead to liquid entering compressor</li> <li>2. The internal parts of compressor damaged</li> <li>3. Compressor lack of oil</li> </ol>	<ol style="list-style-type: none"> <li>1. Change expansion valve</li> <li>2. Change compressor</li> <li>3. Compensate oil for compressor</li> </ol>
5	Fan motor doesn't run	<ol style="list-style-type: none"> <li>1. Fan blade fixing screw is loose</li> <li>2. Fan motor damaged</li> <li>3. Fan motor capacitance damaged</li> </ol>	<ol style="list-style-type: none"> <li>1. Tight the screw</li> <li>2. Change fan motor</li> <li>3. Change the capacitance</li> </ol>
6	Compressor run, but not heat	<ol style="list-style-type: none"> <li>1. There is not refrigerant at all</li> <li>2. Compressor damaged</li> </ol>	<ol style="list-style-type: none"> <li>1. Check leakage and repair</li> <li>2. Change compressor</li> </ol>

---

# Part 4. Warranty card

## Warranty card

Product model:

Bar code:

Buyer		Address	
Invoice No.		Date	
Repair date	Repair record		Repairer

---

### Items of warranty:

1. Warranty terms: \_\_\_\_\_; Within warranty, any problem because of quality, please contact us for support.
2. When repair needed, please show the warranty card and invoice of order or other proof.
3. We don't afford the problem that is caused by re-fitment or adding other function by user.
4. Warranty card and invoice or other purchasing proof will be invalid if alerted.
5. Please keep the warranty card and invoice or other purchasing proofs well, we will need these for service purpose.
6. We will not provide free warranty for below conditions:
  - The delivery time of products or accessories exceeds the warranty time promised by the company.
  - The unit is damaged because the internal factory parameters are changed by the user without permission.
  - Modification of installation accessories without permission (such as
  - lengthened connecting pipe exceeding the limit) leads to unit damage
  - When the weather below 0 degrees, due to power failure, Water pump failure or other reasons other than the unit itself caused by the unit which can not automatically freeze, resulting in the unit frozen;
  
  - Machine damage caused by failure to install or use according to instructions
  - Damage caused by non-standard installation site (such as dust, corrosion,
  - Damage caused by impact during transportation, but the unit has
  - signed for it; Machine damage caused by force majeure (such as flood, earthquake, typhoon, lightning, etc.)

## CERTIFICATE

Product Model: \_\_\_\_\_

\_\_\_\_\_

Bar code: \_\_\_\_\_

\_\_\_\_\_